

HYDRON

MU

**User Manual
Service Book**

MU

INDEX

1. MAIN SPECIFICATIONS	5
2. INTRODUCTION	6
3. TECHNICAL CHARACTERISTICS	6
4. UNPACKING AND VERIFICATION OF THE CONTENTS	8
5. PRIOR WARNINGS	8
6. INSTALLATION AND INITIAL OPERATION	10
7. OPERATION	12
8. USER INTERFACE	13
9. MAINTENANCE AND CONSUMABLES	13
10. WARRANTY	16
11. INSTALLATION AND INITIAL OPERATION SHEET	17
12. MAINTENANCE SERVICE BOOK	18

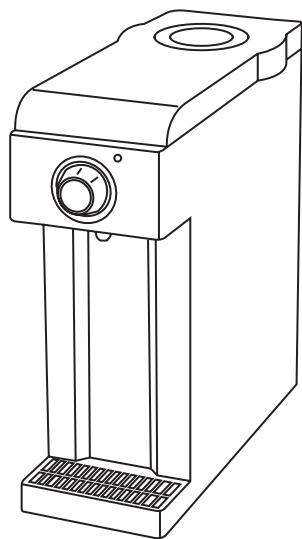



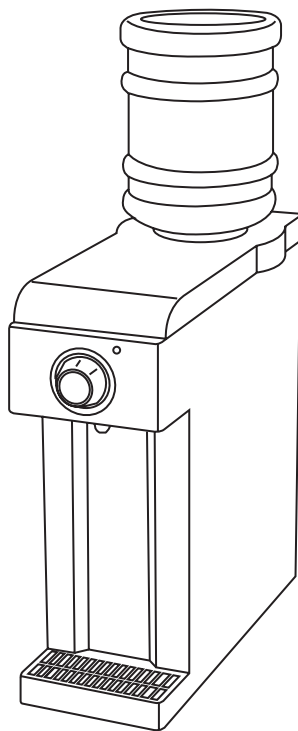



HYDRON



HYDRON B

1. MAIN CHARACTERISTICS

	<p>Generation of hydrogen.</p>
	<p>Reduction of the oxidation reduction potential (ORP).</p>
	<p>Easy installation under the sink.</p>
	<p>Easy maintenance.</p>
	<p>Does not treat tap water.</p>
	<p>It treats filtered water / RO.</p>

The technical characteristics are common to both.

2. INTRODUCTION

Congratulations.

You have purchased an excellent equipment to treat water for human consumption, which increases the hydrogen concentration dissolved in water, reduces the ORP and adjusts the pH.

What is hydrogen?

Hydrogen is a chemical element with the atomic number 1. It is the lightest element and the most abundant in the universe, though not on the Earth. Hydrogen is rather common in nature along with other elements such as oxygen, carbon or nitrogen (it is a part of water, the human body, animal and vegetable organisms, etc.).

What is the water oxidation reduction potential (ORP)?

The ORP measures the tendency of water and its compounds in solution to produce oxidation (positive potential) and/or a reduction (negative potential).

What is the pH of water?

The pH is an indicator of the acidity of a substance. It is determined by the amount of free hydrogen ions (H^+) in a substance. The pH of water may vary from 0 to 14. When the pH of a substance is higher than 7, it is a basic substance. When the pH of a substance is lower than 7, it is an acidic substance. The greater the deviation of the pH is above or below 7, more basic or acidic will the solution be.

3. TECHNICAL CHARACTERISTICS

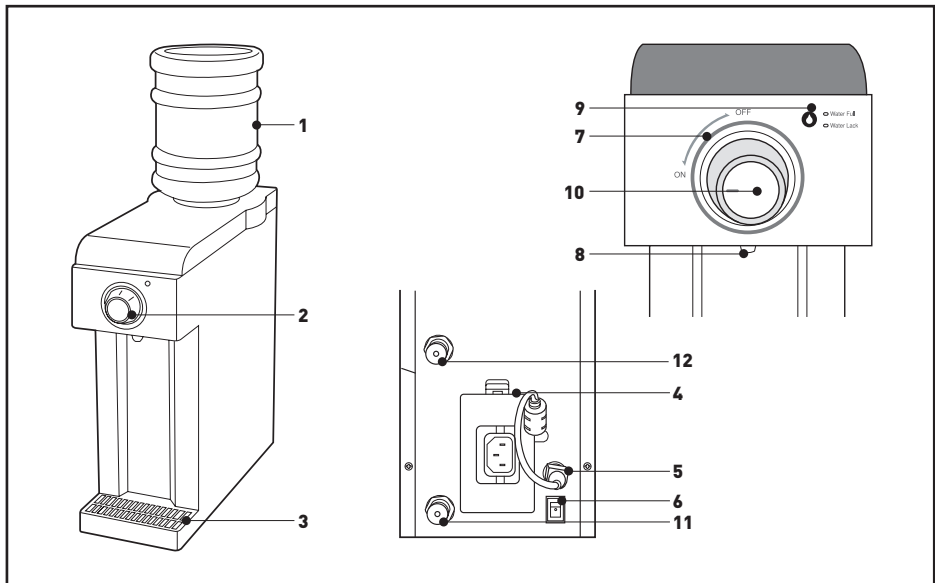

NUMBER	DESCRIPTION	
1	Refillable tank (Model B).	
2	Dispenser control. Light indicator.	
3	Drip tray.	The equipment does not have a drain and must be regularly emptied and cleaned.
4	Cover of the electric power supply compartment.	
5	Power supply connector of 24Vdc to the equipment.	
6	Operation switch.	
7	Visual progress indicator.	If it lights up sequentially from right to left: the equipment is working properly. When all lights flicker at the same time: the hydrogenation cells are out of service and must be replaced.
8	LED illuminator for dispensed water. Trim for water dispenser.	
9	Flow rate indicator of inlet water to be treated.	Blue LED on: inlet flow is enough. Red LED on: inlet flow is insufficient.
10	Water dispenser control.	Dispenses water when turned counterclockwise. Stops dispensing water when turned clockwise.
11	1/4" connector for inlet water to be treated.	Hydron model.
	Purge connector to empty the tank.	Hydron B model.
12	1/4" connector for water output to be consumed.	Hydron model.

Technical Information

Dimensions (A x B x C):

Weight (in kg):

Power supply:

Working pressure (min. - max.):

Working temperature (min. - max.):

Inlet water:

Hardness (max.):

Chlorine:

MODEL A / MODEL B

148 mm x 360 mm x 360 mm

4.5 kg (empty)

DC 24 V / 5 A

1 bar - 5 bar

5°C - 35°C

Osmotized or mineral water of similar quality

< 5°HF

Chlorine-free

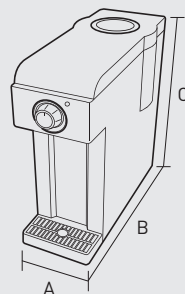

DISTRIBUTED BY:

IONFILTER. PURICOM EUROPE. PURICOM AMÉRICA

Pol. Ind. L'Ametlla Park. C. Aiguafreda, 8.

08480 L'Ametlla del Vallès. Barcelona (Spain)

T. 902 305 310 / +34 936 934 300 F. +34 936 934 329

4. UNPACKING AND VERIFICATION OF THE CONTENTS

Before installation and initial operation it is important to check the contents of the box and the condition of the equipment in order to check it has not been damaged during transport.

Claims due to damage in transit should be submitted along with the delivery sheet or purchase receipt to the distributor, including the name of the freight company within 24 hours after reception of the equipment.

Unpack the equipment and its accessories from its packaging and dispose of any protective packaging material.

The materials used for the packaging are recyclable and should be disposed of in the appropriate recycling bins or at the specific local waste product recycling centre.

This product cannot be disposed of with other domestic waste products. If you wish to dispose of it, the equipment should be returned to the place of purchase, or at a local recycling centre, indicating that said equipment contains electric and electronic components.

The correct collection and treatment of products, which no longer are to be used, contributes to the preservation of natural resources and avoids any potential public health risks.

Warning: Dispose of the plastic bags and the small pieces or keep them away from children, since they may be dangerous for them. Scope of supply: treatment equipment, drip tray and documents.

5. PRIOR WARNINGS

Warning: Please read this manual carefully before installing and using the equipment.

Warning: This equipment IS NOT A WATER PURIFIER. It must not be fed with water from an unknown source and/or which does not comply with the drinkability requirements demanded by the European Directive 98/83 and/or RD 140/2003.

Warning: The water treatment equipment needs to undergo periodic maintenance, which must be carried out by qualified technical personnel to guarantee the quality of water produced and supplied.

5.1.- WARNINGS FOR APPLICATION AND INSTALLATION

This equipment is recommended to use as a post-treatment of a reverse osmosis domestic water treatment system with pressure tank.

The system should be supplied with osmotized water or mineral water of similar quality.

If the equipment is fed with hard or non-softened water, the service life of certain components of the equipment may be substantially reduced, which would lead to a premature malfunction.

The maximum pressure of inlet water is of 5 bar. Install a pressure regulator at the inlet of the equipment set to less than 5 bar, when necessary.

Warning: If the equipment is fed with water from a reverse osmosis domestic water treatment equipment controlled by a mechanical shut-off valve and the pressure of the network exceeds or may exceed 5 bar, the pressure of the water dispensed by the osmosis equipment may exceed 5 bar. Therefore it would be necessary to install a pressure regulator between the outlet of the osmosis equipment and the inlet of the hydrogenator.

The equipment requires a power supply within 1 metre of distance.

Warning: The equipment must not be installed horizontally or tilted (1). Do not install the equipment in tilted or unstable places. Otherwise, it might fall or cause a malfunction.

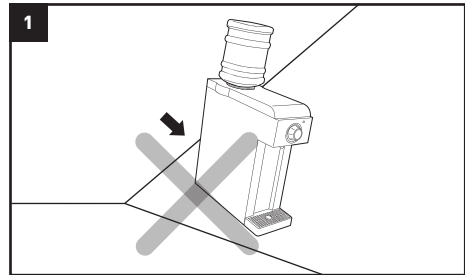

The installation location should have sufficient space for the machine itself, its accessories, connections and room for servicing and repair.

Under no circumstances should the equipment be installed outdoors or in places subject to direct sunlight. Do not install the equipment in wet places or close to flammable products.

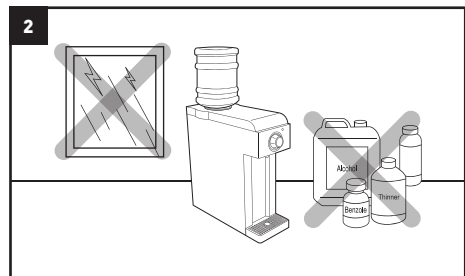

The system should not be installed next to a heat source or where it receives a direct flow of hot air (dryer, dishwasher, refrigerator, heater, boiler, etc.).

- The equipment must not be installed in front of a cooling system or an air-conditioned equipment.
- The equipment must not be installed close to a heater or boiler working with a flame.
- The surroundings and the environment where the system and the tap are to be installed must meet the appropriate hygienic and sanitary conditions.
- Avoid external drips from pipes, drains, etc. onto the system.
- To fill the system for the first time, let it fill with water to be treated before plugging in the equipment.
- The equipment cannot be installed in places where room temperatures can get lower than 5°C, since the water inside could freeze and damage the product (3).

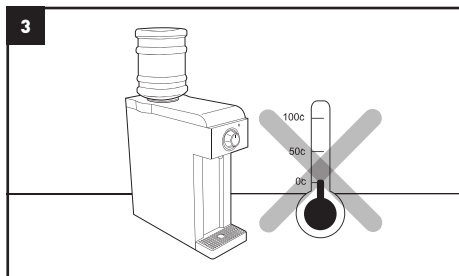

- Do not manipulate the equipment's electrical connectors with wet hands. There could be a risk of an electric shock (4).
- Plug it firmly. An unsafe connection may cause a fire (5).
- Do not pull the power supply cable to unplug it from the wall outlet, since it could cause a fire or an electric shock (6).

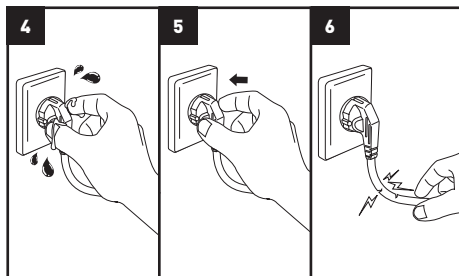

5.2. WARNINGS FOR USE

- Should you be away from home for more than a week,

close the water inlet, empty the system and unplug from the power supply. On your return connect the power supply, open the inlet valve and empty two litres of water through the tap before drinking it.

! Warning: Following a prolonged period (more than a month) during which the system has not been in operation or dispensed water, contact your distributor or Technical Service in order to carry out the proper cleaning and maintenance.

To optimise the performance of the system, extract full jugs and bottles and avoid the occasional extraction of water glasses.

! Warning: Special attention must be paid to the regular cleaning and hygiene of the water dispenser tap, specially during periodic maintenance. Under no circumstances must a hand towel or a multi-use cloth for the kitchen be used.

- Do not either drink directly from the dispenser or lean the bottle or a vessel against the tap or the dispenser.
- After the initial operation, empty 5 litres before drinking the water.
- Do not use the equipment for more than 30 minutes in a row since some components might overheat.

! Warning: pH must be between 6.5 and 9.5 according to RD 140/2003.

- Do not feed the equipment with hot water.
- Do not attempt to disassemble, repair or modify the equipment arbitrarily after a failure. Maintenance and repair must be carried out by a qualified technician (7).

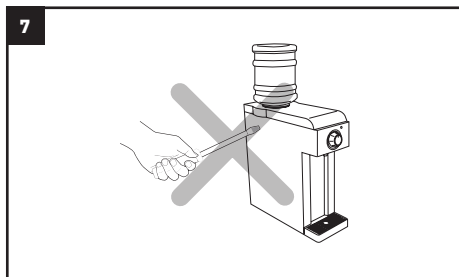

- Do not leave cigarettes or products with a flame on the equipment, since they could cause a fire (8, next page).
- Before moving the equipment, close the water inlet valve and empty it through the front dispenser. Using the rear connector, open the upper cover and empty the inner tank. Then unplug it from the power supply. Place a cap in the rear connector.

- If you need to move the equipment, empty it through

the front dispenser and do not tilt it more than 15°.

equipment to facilitate its maintenance (10).

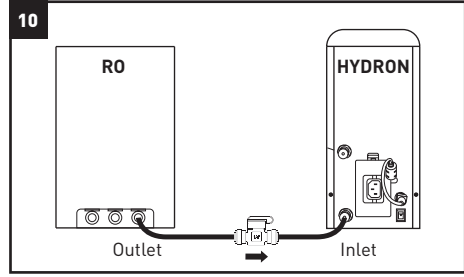
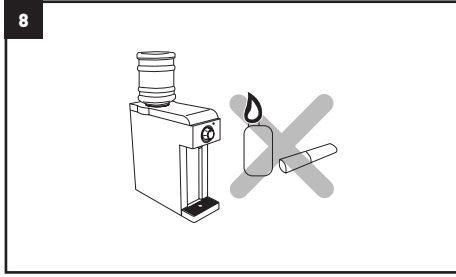

5.3. WARNINGS FOR MAINTENANCE

- Consumable parts should be replaced as advised depending on the characteristics of water and the frequency of use. See the corresponding section in this manual.
- The equipment must be regularly sanitised as well as during the initial operation.
- Maintenance must be carried out by a qualified technician under the proper hygienic conditions, in order to reduce the risk of internal contamination of the equipment and its hydraulic system. (For further information contact the Technical Service of your distributor.)

6. INSTALLATION AND INITIAL OPERATION

! **Warning:** To remove the cap from the rear connector, push the retaining ring in the direction indicated by the arrow (towards the connector) and, at the same time, remove the tap by pulling it (9).

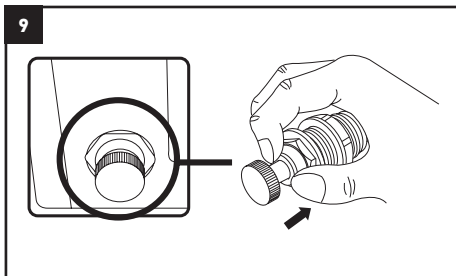

6.1 HYDRON

- Remove the rear cap and connect the 1/4" tube from the reverse osmosis water treatment equipment or from an equipment dispensing a water which complies with the appropriate working limits described in section 3. **TECHNICAL CHARACTERISTICS.**
- It is recommended to install a shut-off valve between the Hydron inlet and the outlet of the water treatment

- Plug the power supply connector into the power supply located in the compartment (11) on the rear of the equipment.
- After 3 minutes, plug the power supply into the corresponding wall outlet (12).
- Turn on the equipment by connecting the round electric adapter to the power supply located on the rear side of the equipment (13) and put the power switch in the ON position (14).
- The light indicator (15) should change from red to BLUE after a few seconds, which means that the system is ready to treat water.
- Using the dispenser control (16), empty 5 litres and dispose of them before drinking the water. The carbon post-filter must be rinsed to clean the carbon dust which may have generated during transport and handling. Repeat this procedure as many times as necessary, until dispensed water runs clear.

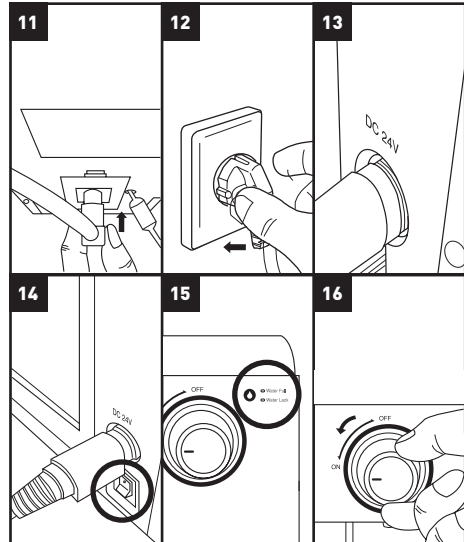

6.1.1. INSTALLATION UNDER THE SINK

- Remove the rear cap labeled as "Faucet" and connect the 1/4" tube from the counter top faucet.

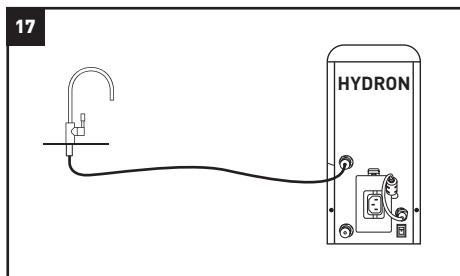

- Keep the dispenser control in the OFF position (18).
- After installation and initial operation, loosen the screws from the rear side (19), remove the upper cover (20) and check the tightness of the system both in stand-by and in operation for several minutes.

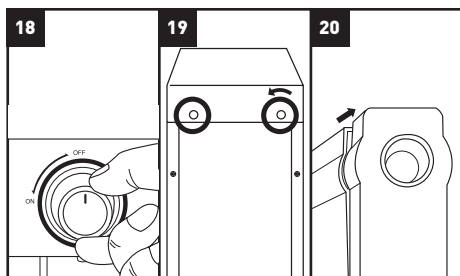

6.2. HYDRON B

- Remove the cap from the tank and rinse both of them with tap water (21).
- Fill the tank with water from an osmosis equipment (22) or with water complying with the adequate working limits indicated in the **3. TECHNICAL CHARACTERISTICS** section.

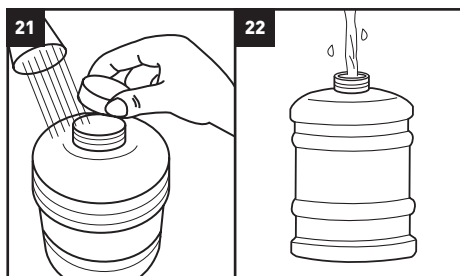

- Close the inner side of the cap and screw it in the tank (23).
- Place the tank in the adapter located on the rear part of the equipment, upside down, and insert the cap in it (24).

- Plug the power supply connector to the power supply located in the compartment on the rear of the equipment (25).

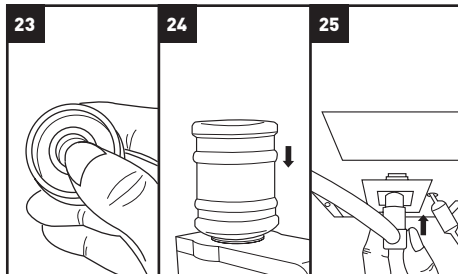

- After 3 minutes, plug the power supply to the corresponding wall outlet (26).

- Turn on the equipment by connecting the round electric adapter to the power supply located on the rear side of the equipment (27) and put the power switch in the ON position (28).

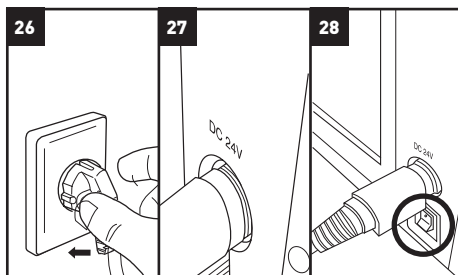

- The light indicator (29, next page) should change from RED to BLUE after a few seconds, which means that the system is ready to treat water.

- Using the dispenser control (30, next page), empty 4 tanks and dispose of them before drinking the water. The carbon post-filter must be rinsed to clean the carbon dust which may have generated during transport and handling. Repeat this procedure as many times as necessary, until dispensed water runs clear. The light indicator (29, next page) indicates the lack of water by turning RED. In this case, remove the tank and fill again as described above.

- After installation and initial operation, and after emptying the last tank, loosen the screws from the rear side (31, next page), remove the upper cover (32, next page) and check the tightness of the system both in stand-by and in operation for several minutes.

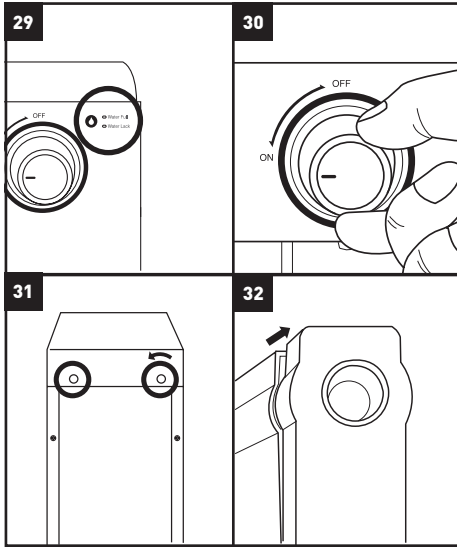

7. OPERATION

7.1. DESCRIPTION

- The flow rate of water to be treated can be adjusted with a small regulating tank (1). The inlet flow is regulated by means of a floating valve (2), composed of a minimum level probe (3), which stops the system when it detects that the water level is insufficient.
- Water to be treated goes through the hydrogenation chamber (4) and gets sucked by the boost pump (5) towards a mixing valve (8) and a carbon filter (9) whose aim is to remove all possible odours that water may have acquired.
- Both pumps (5 & 6) and the hydrogenation cell (4) only work when the system detects it must dispense water (by turning the control of the dispenser valve (11)) by means of a high pressure switch (10) located between the dispenser tap (11) and the carbon filter (9), provided that there is a sufficient water level.

Operating diagram

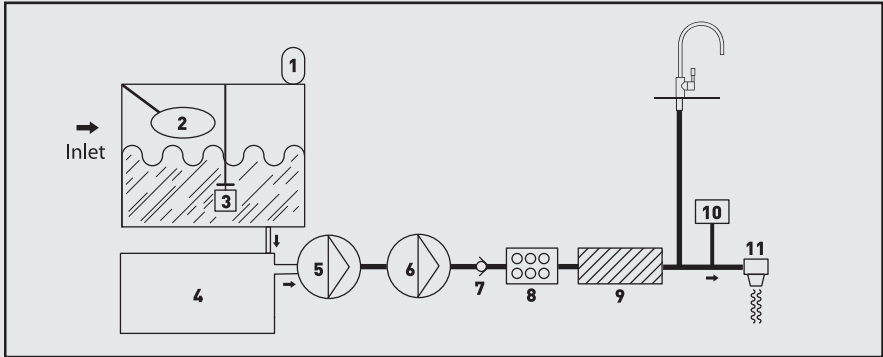

COMPONENTS

- 1) Regulating tank
- 2) Floating valve for filling
- 3) Minimum level probe
- 4) Hydrogenation cell
- 5) Pump
- 6) Pump
- 7) Check-valve
- 8) Mixing valve
- 9) Carbon filter
- 10) High pressure switch
- 11) Dispenser tap

8. USER INTERFACE

The system is equipped with a state-of-the-art electronic controller which manages and adjusts the functioning of the various components and provides information on the state of the system at all times.

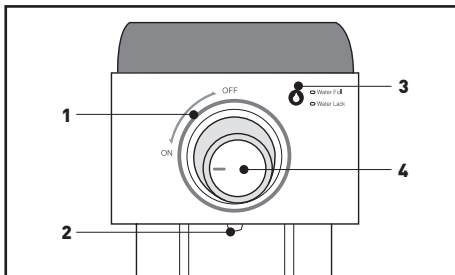

1) Visual progress indicator

If it lights up sequentially from right to left (clockwise): the equipment is working properly.

When all lights flicker at the same time: the hydrogenation cells are out of service and must be replaced. In this case, close the inlet valve of the equipment, unplug it from the power supply and contact the Technical Service.

2) LED illuminator for dispensed water

Trim for water dispenser.

3) Flow rate indicator of inlet water to be treated

Blue LED on: inlet flow is enough.
Red LED on: inlet flow is insufficient.

4) Water dispenser control

Dispenses water when turned counterclockwise. Stops dispensing water when turned clockwise.

9. MAINTENANCE AND CONSUMABLES

Warning: The equipment is not a water purifier.

Some of the components of your equipment are consumable parts with a limited service life and so, they must be regularly replaced.

9.1. HOW TO REPLACE THE CARBON FILTER

- Close the inlet valve and open the dispenser valve until the tank gets empty and stops dispensing water (Red light indicator. Insufficient flow of water to be treated).
- Remove the upper cover and the side panel by loosening the rear screws.

- Rinse the new carbon post-filter before replacing it to remove the carbon dust which may have generated during transport and handling.
- Reassemble the equipment and turn it on again.
- Extract and dispose of 5 litres of water before drinking it.

9.2. CLEANING

- Close the inlet valve and open the dispenser valve until the tank gets empty and stops dispensing water (Red light indicator. Insufficient flow of water to be treated).
- Remove the upper cover by loosening the rear screws.
- Empty the tank. For the Hydron model, tilt the equipment and pour the remaining water in the sink or a vessel. For the Hydron B model, empty the tank by removing the cap of the rear connector (33) and guiding it towards the drain, the sink or a vessel.

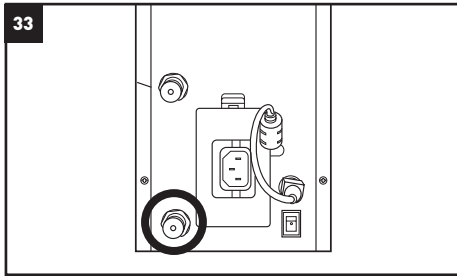

- Clean the tank using single-use blotting paper dampened with tap water containing chlorine from the public supply.
- Clean the jug, the tank or the bottle adequately (only for the Hydron B model).
- Turn on the equipment again and wait until the tank is full while it is in stand-by mode without dispensing water. Then add 2 drops of Bakwater into the tank.

! Warning: A higher dose may damage the main components of the system. Do not use peroxide-based cleaning products.

- Reassemble the equipment and wait 15 minutes for the cleaning product to work. Extract half litre of water and reject it. Wait for 15 minutes.
- Use an appropriate surface cleaning product and blotting paper to clean the dispenser nozzle and/or the faucet.
- Extract and reject 5 litres of water to rinse the system and remove any residual cleaning product before drinking it.

9.3. RECOMMENDED MAINTENANCE

- Replacement of the carbon filter:
Every 6 to 12 months in function of use.
- Cleaning:

During the initial operation.

Every 6 to 12 months in function of use.

Each time access is made with components in contact with the equipment's water or if water has not been consumed during more than one month.

9.3. TROUBLESHOOTING QUICK GUIDE

PROBLEM	CAUSE	SOLUTION
The LEDs on the front do not light up and the equipment is not working.	No power supply in the equipment.	Check that the power supply cable is firmly connected to both the equipment and the wall outlet. Check the circuit breakers and the protections of the electrical installation or consult a professional. If the problem persists, contact the Technical Service.
	Rear switch is in the OFF position.	Put the switch in the ON position.
Water is not dispensed when requested.	If the front flow indicator lights up in RED, there is no inlet pressure.	Check the water supply/fill the jug (in function of the model). If the problem persists, contact the Technical Service.
The front progress indicator flickers at the same time.	Turn on and off the equipment from the power supply using the rear switch.	If the problem persists, contact the Technical Service.
Bad taste.	Check the characteristics of water to be treated	If the problem persists, isolate and unplug the equipment and contact the Technical Service.
Burnt smell during functioning.		Isolate and unplug the equipment and contact the Technical Service.

10. WARRANTY

END USER WARRANTY:

The distributor guarantees this equipment for a period of two years against any fault found, and in accordance with the provisions of RD (Royal Decree) 1/2007 of the 16th of November (Amended text of the General Law for the Protection of Consumers and Users). This guarantee encompasses reparation and replacement of defective parts by personnel authorised by the distributor or by the Official Technical Assistance Service (SAT), either at the location of installation or at their respective workshops. Labour and shipping costs incurred by said repairs are included in the guarantee. IF/PEU/PAM will not be liable to honour the warranty in the event of parts, which are subject to general wear and tear, lack of due maintenance, damage or other incidents due to the consequence of misuse or inappropriate use in accordance with conditions, and functional limits of said equipment as indicated by the manufacturer. Furthermore, the warranty will be rendered invalid in the event of poor use or in the event of said equipment being modified or repaired by personnel not authorised by the distributor or by the official SAT. Replacement parts under warranty shall remain the property of IF/PEU/PAM.

IF/PEU/PAM shall be held responsible for any lack of conformity of equipment in relation to its origin, identity or appropriateness of the products, in accordance with equipment type and end use. Taking into account the equipment's characteristics, in order for the warranty to cover any lack of conformity, the adherence to the installation and working technical conditions which appear in this warranty is essential, as well as the submission of either a sales invoice or receipt. Failure to comply with said conditions may invalidate this warranty, taking into account the relevance of the equipment's aim and conditions and working limits.

The distributor guarantees that the installed equipment is appropriate for the improvement of the quality of the water to be treated, in accordance with the equipment's characteristics and current legislation. The installation personnel and/or distributor guarantees the correct installation and initial operation of the equipment in accordance with the manufacturer's instructions and any current legislation, and will be responsible for any lack of conformity which arises from any incorrect application, installation or initial operation of said equipment.

For any warranty claim the submission of the sales receipt is required. The 2-year period is calculated from the date the equipment is purchased from the distributor. If during the warranty period the equipment encounters any issues please contact your local distributor.

In case of installation of the equipment, with non-osmotic water or salinity higher than 100 ppm and hardness higher than 5°HF, IF / PEU / PAM * will not be responsible for faults, malfunctions and consequences thereof.

* IF/PEU/PAM = IONFILTER/PURICOM EUROPE/
PURICOM AMÉRICA

IDENTIFICATION OF THE SYSTEM:

Serial number

The equipment has been installed and is working in a satisfactory manner for the client and for the record:

*Pre-treatment of the system:

*Equipment entry hardness [°F]:

*Equipment entry TDS [ppm]:

*Equipment entry pressure [bar]:

*Installation and initial operation service result sheet

CORRECT.

OTHER INFORMATION:

The equipment's owners have been suitably and clearly informed of the use and maintenance required to ensure its correct working and of the quality of water to be produced. To these effects a maintenance contract is offered.

*Ref. Maintenance contract

Maintenance contract IS ACCEPTED.

Maintenance contract is NOT ACCEPTED.

In the event of needing further information, to report a breakdown or fault, please request either maintenance or technical assistance. Please read the sections relating to troubleshooting in this manual and contact the distributor or retailer.

AUTHORISED COMPANY AND/OR INSTALLER: (date and signature)



AUTHORISED COMPANY AND/OR TECHNICIAN:
Information marked with an (*) should be filled in by the installation technician.

TECHNICAL ASSISTANCE LINE

11. INSTALLATION AND INITIAL OPERATION REGISTRATION SHEET. TECHNICIAN

! NOTES FOR TECHNICIAN/INSTALLER: Please read this manual carefully.
 In the event of any queries please contact your distributor's Technical Assistance Service (S.A.T.).
 Information marked with an (*) should be filled in by the installation technician and copied to the WARRANTY SHEET.
 This document should be retained by the installer/distributor as it may be requested by IF/PEU/PAM, with the aim of improving customer and after sales service.
 The technician who carries out the installation and initial operation should be suitably qualified.

Serial number

INFORMATION REGARDING THE EQUIPMENT'S APPLICATION:

Source of water to be treated:

- *Pre-treatment of the system:
- *RO equipment entry hardness [°F]:
- *RO equipment entry TDS [ppm]:
- *RO equipment entry pressure [bar]:

INSTALLATION PROCESS CONTROL:

- Carbon filter cleaning.
- Sanitation in accordance with protocol.
- Review and fittings.
- Pressurized system water tightness check.
- *H₂ produced water [ppm]:
- ORP:
- Clearly inform of the correct use and maintenance required to ensure correct working of the equipment and for the quality of the water produced. Given the importance that correct equipment maintenance has to ensure the quality of water to be produced, the owner of the equipment should be offered a maintenance contract by suitably qualified technicians.

COMMENTS

*Installation and initial operation results:

CORRECT (equipment installed and working properly).

Produced water is suitable for this application)

OTHER INFORMATION:

TECHNICIAN IDENTIFICATION:

Company and/or installer, date and signature

CONFORMITY OF EQUIPMENT OWNER:

I have been clearly informed regarding the correct use and maintenance required for the installed equipment, and have been offered a maintenance contract as well as being informed of how to contact the Customer Service Department in the event of wishing to make any information requests, to report an equipment breakdown or malfunction, or to request any technical services.

Comments

***Ref. Maintenance contract**

- The maintenance contract IS ACCEPTED.
- The maintenance contract is NOT ACCEPTED.

Model / Ref.:

Owner, Mr/Mrs/Ms:

Street:

Telephone No.:

Town/City:

State/County: Post Code:

Date and signature:

12. MAINTENANCE SERVICE BOOK



DATE		TYPE OF SERVICE		NAME, SIGNATURE AND STAMP AUTHORISED TECHNICIAN	
/	/	<input type="checkbox"/>	INITIAL OPERATION	TECHNICIAN	
/	/	<input type="checkbox"/>	MAINTENANCE COMPLETE	STAMP	<input type="checkbox"/> ORDINARY
/	/	<input type="checkbox"/>	REPAIR		<input type="checkbox"/> EXTRAORDINARY
/	/	<input type="checkbox"/>	SANITATION		<input type="checkbox"/> WARRANTY
/	/	<input type="checkbox"/>	OTHERS		
/	/	<input type="checkbox"/>	MAINTENANCE COMPLETE		TECHNICIAN
/	/	<input type="checkbox"/>	REPAIR	STAMP	<input type="checkbox"/> EXTRAORDINARY
/	/	<input type="checkbox"/>	SANITATION		<input type="checkbox"/> WARRANTY
/	/	<input type="checkbox"/>	OTHERS		
/	/	<input type="checkbox"/>	MAINTENANCE COMPLETE		TECHNICIAN
/	/	<input type="checkbox"/>	REPAIR	STAMP	<input type="checkbox"/> EXTRAORDINARY
/	/	<input type="checkbox"/>	SANITATION		<input type="checkbox"/> WARRANTY
/	/	<input type="checkbox"/>	OTHERS		
/	/	<input type="checkbox"/>	MAINTENANCE COMPLETE		TECHNICIAN
/	/	<input type="checkbox"/>	REPAIR	STAMP	<input type="checkbox"/> EXTRAORDINARY
/	/	<input type="checkbox"/>	SANITATION		<input type="checkbox"/> WARRANTY
/	/	<input type="checkbox"/>	OTHERS		
/	/	<input type="checkbox"/>	MAINTENANCE COMPLETE		TECHNICIAN
/	/	<input type="checkbox"/>	REPAIR	STAMP	<input type="checkbox"/> EXTRAORDINARY
/	/	<input type="checkbox"/>	SANITATION		<input type="checkbox"/> WARRANTY
/	/	<input type="checkbox"/>	OTHERS		
/	/	<input type="checkbox"/>	MAINTENANCE COMPLETE		TECHNICIAN
/	/	<input type="checkbox"/>	REPAIR	STAMP	<input type="checkbox"/> EXTRAORDINARY
/	/	<input type="checkbox"/>	SANITATION		<input type="checkbox"/> WARRANTY
/	/	<input type="checkbox"/>	OTHERS		
/	/	<input type="checkbox"/>	MAINTENANCE COMPLETE		TECHNICIAN
/	/	<input type="checkbox"/>	REPAIR	STAMP	<input type="checkbox"/> EXTRAORDINARY
/	/	<input type="checkbox"/>	SANITATION		<input type="checkbox"/> WARRANTY
/	/	<input type="checkbox"/>	OTHERS		
/	/	<input type="checkbox"/>	MAINTENANCE COMPLETE		TECHNICIAN

12. MAINTENANCE SERVICE BOOK

DATE		TYPE OF SERVICE		NAME, SIGNATURE AND STAMP AUTHORISED TECHNICIAN	
/	/	<input type="checkbox"/>	INITIAL OPERATION	TECHNICIAN	
/	/	<input type="checkbox"/>	MAINTENANCE COMPLETE	STAMP	<input type="checkbox"/> ORDINARY
/	/	<input type="checkbox"/>	REPAIR		<input type="checkbox"/> EXTRAORDINARY
/	/	<input type="checkbox"/>	SANITATION		<input type="checkbox"/> WARRANTY
/	/	<input type="checkbox"/>	OTHERS		
/	/	<input type="checkbox"/>	MAINTENANCE COMPLETE	TECHNICIAN	<input type="checkbox"/> ORDINARY
/	/	<input type="checkbox"/>	REPAIR	STAMP	<input type="checkbox"/> EXTRAORDINARY
/	/	<input type="checkbox"/>	SANITATION		<input type="checkbox"/> WARRANTY
/	/	<input type="checkbox"/>	OTHERS		
/	/	<input type="checkbox"/>	MAINTENANCE COMPLETE		TECHNICIAN
/	/	<input type="checkbox"/>	REPAIR	STAMP	<input type="checkbox"/> EXTRAORDINARY
/	/	<input type="checkbox"/>	SANITATION		<input type="checkbox"/> WARRANTY
/	/	<input type="checkbox"/>	OTHERS		
/	/	<input type="checkbox"/>	MAINTENANCE COMPLETE		TECHNICIAN
/	/	<input type="checkbox"/>	REPAIR	STAMP	<input type="checkbox"/> EXTRAORDINARY
/	/	<input type="checkbox"/>	SANITATION		<input type="checkbox"/> WARRANTY
/	/	<input type="checkbox"/>	OTHERS		
/	/	<input type="checkbox"/>	MAINTENANCE COMPLETE		TECHNICIAN
/	/	<input type="checkbox"/>	REPAIR	STAMP	<input type="checkbox"/> EXTRAORDINARY
/	/	<input type="checkbox"/>	SANITATION		<input type="checkbox"/> WARRANTY
/	/	<input type="checkbox"/>	OTHERS		
/	/	<input type="checkbox"/>	MAINTENANCE COMPLETE		TECHNICIAN
/	/	<input type="checkbox"/>	REPAIR	STAMP	<input type="checkbox"/> EXTRAORDINARY
/	/	<input type="checkbox"/>	SANITATION		<input type="checkbox"/> WARRANTY
/	/	<input type="checkbox"/>	OTHERS		
/	/	<input type="checkbox"/>	MAINTENANCE COMPLETE		TECHNICIAN
/	/	<input type="checkbox"/>	REPAIR	STAMP	<input type="checkbox"/> EXTRAORDINARY
/	/	<input type="checkbox"/>	SANITATION		<input type="checkbox"/> WARRANTY
/	/	<input type="checkbox"/>	OTHERS		

MU