



Household
Water Softener STRATOS Series
**INSTALLATION, START-UP
AND MAINTENANCE MANUAL**

Stratos

MAIN FEATURES OF THE STRATOS SERIES



Meter delayed or immediate

Metered regenerations can be programmed.



Mixing valve

Allows the adjustment of the residual hardness degree.



Built-in By-pass

The system can be isolated from the installation.



Transformer

External transformer.



Easy salt refilling

Easy water softener salt refilling.



Multilingual programmer

The user can select the following languages: English, French and Spanish .



Certified product

Official certificates.



Optimized regeneration

The regeneration process has been adjusted in order to reduce salt and water consumption (up to 50% of salt and a 40% of water).



Adjustable regenerating degree

Several regeneration degrees can be adjusted according to the hardness of water to be treated and the desired efficiency.



State-of-the-art display

Interactive display with multicolour icons.



Functional and smart design

It will fit in your home like any other electrical appliance.



Holiday Mode

It allows the user to program low consumption periods in which the system will carry out small washes.



PLEASE KEEP THIS MANUAL, SINCE IT INCLUDES THE SERVICE BOOK AND THE WARRANTY, IN ORDER TO BE ABLE TO OFFER YOU A BETTER AFTER-SALES SERVICE.

1. PRESENTATION	6
1.1 Water Softener Safety	6
1.2 What To Do Before	6
2. INTRODUCTION	7
2.1 What Is Hardness?	7
2.2 How Does Your System Work?	7
2.3 Regeneration of the System	8
2.4 Regeneration Degree and Capacity	9
2.5 Working flows	9
2.6 Hardness Leakage	9
2.7 Residual hardness	9
2.8 Sodium Increase	10
3. TECHNICAL SPECIFICATIONS	11
4. UNPACKING AND VERIFICATION OF THE CONTENTS	12
5. PREVIOUS WARNINGS	12
5.1 Conditions for the proper operation of the system	12
5.2 Installation of the system	13
5.3 Start-up and maintenance	14
6. INSTALLATION OF THE SYSTEM	14
6.1 Required Tools and Pieces	14
6.2 Step-by-Step Installation	14
6.3 STRATOS Programmer	16
6.4 How to Program the System	17
7. START-UP	19
7.1 Hydraulic Start-up	19
7.2 Residual Hardness Regulation	20
7.3 How to check for Hardness	21
8. MAINTENANCE / HYGIENISATION	21
9. GUIDE FOR THE IDENTIFICATION AND SOLUTION OF PROBLEMS	23
10. MAINTENANCE SERVICE BOOK	24
11. NOTES	26
12. EC DECLARATION	27
13. GUARANTEE	27

1. PRESENTATION



The system you have just bought is a state-of-the-art equipment, able to deliver softened water to your home.

Developed and designed by IONFILTER, a leading company from the industry with more than 20 years of experience; this equipment will deliver softened water without scaling salts, thus protecting your water supplies, avoiding the obstruction of all pipes and allowing you to enjoy the benefits of softened water.

The quality of the water in our environment is getting worse every day, leading to an increase in water hardness, which causes problems in pipes and affects the proper operation of appliances using water, by increasing the maintenance and reducing their service life.

The reality of this is what has driven us to design this series of domestic water softeners, in order to provide you with a water of the highest quality.

Your STRATOS H.E. water softener will provide you and your family the benefits and advantages outlined below:

- ENERGY SAVING
- Greater wellness feeling.
- Soft and smooth skin.
- Increases the service life of electrical appliances and heaters.
- ECONOMIC SAVING: it reduces the consumption of soap, fabric softeners and chemical products.
- Low maintenance cost.
- Operation is completely automatic.

! It is very important that you read and keep this manual before installation and start-up of the system. If you have any questions regarding the use or maintenance of this system, please contact the Technical Assistance Service (TAS) of your distributor.

1.1 Safety of the Water Softener



Your safety and that of others is very important. We have included some safety messages in this manual.



This is the symbol for a safety alert. This symbol will warn you about possible situations in which you or those around you could be at risk.

All safety messages will have the alert symbol or the words **'DANGER'** or **'WARNING'**.

USE WITHIN THIS MANUAL



'DANGER'

Serious or life-threatening risk if the following instructions are not immediately followed.



'WARNING'

All safety messages will inform about the possible danger, how to reduce the injury risk and what might happen if the instructions are not followed.

1.2 What To Do Before



See section 'Previous warnings' before installing the water softener.

Carefully follow the instructions for the installation. (Warranty may be considered void, should the installation be faulty).

Please read the entire manual before undertaking installation. Then, collect all necessary materials and tools for the installation.

Check the plumbing installations and the electric connectors.

All installations must be done according to the law in force in each region or country.

Please be careful when handling the water softener. Do not knock it over, let go of it or place it onto sharp objects.

Under no circumstances should the softener be installed on the outside, since it must be protected against sunlight and bad weather conditions.

2. INTRODUCTION



These systems come with a residual hardness regulator as standard, which allows selecting the appropriate hardness for your home.

Its friendly-use electronic programmer will allow you to put the system into operation in an easy and fast manner.

2.1 What Is Hardness?



Hardness is the quantity of scaling salts present in water, which are mainly composed of low solubility salts of calcium and magnesium. The main salts causing hardness are listed below:

Calcium bicarbonate:	$\text{Ca}(\text{CO}_3\text{H})^2$
Calcium chloride:	CaCl_2
Calcium sulphate:	CaSO_4
Magnesium bicarbonate:	$\text{Mg}(\text{CO}_3\text{H})^2$
Magnesium chloride:	MgCl_2
Magnesium sulphate:	MgSO_4

These salts, due to its chemical properties, have a tendency to precipitate, producing scale on pipes and obstructing them as they accumulate. In the same way, hardness has a high tendency to scale on electrical resistors from heaters and to precipitate into heaters when temperature increases.

The combination of hard minerals and soap produces a soap curdling. This soap curdling reduces the cleansing properties of soap. Hard minerals precipitation builds a layer on cooking utensils, connections and plumbing fixtures. It may even alter the taste of food.

MAIN PROBLEMS

- Precipitation on pipes, fixtures and appliances.
- Precipitation on electrical resistors, increase on energy consumption due to the generated isolation.
- Higher consumption of soap and chemical products.
- Reduction of the electrical appliances' service life and greater maintenance.

All these problems are solved when using a water softener, since water obtained after being treated by the system is completely free of scaling salts.

For the most part of Europe, hardness is indicated in French hydrometric degrees, but there are also other measuring units, according to each region.

Below are the most usual equivalences.

UNITS	ppm of CaCO_3	° French
1 ppm of Calcium	2,5	0.25
1 ppm of Magnesium	4,13	0.413
1 ppm of CaCO_3	1	0.1
1° French (°HF)	10	1
1° German (°d)	17,8	1.78
1° English (°e)	14,3	1.43
1 mmol/L	100	10
1 mval/L=meq/L	50	5

2.2 How Does Your System Work?



Water softening is carried out by means of an ion exchange process. On this purpose, the system uses resins with the chemical capacity of capturing Calcium (Ca) and Magnesium (Mg) ions and removing them from water.

When Calcium and Magnesium ions are captured by the resin, two Sodium (Na) ions are released which, due to its chemical properties, produce salts with a higher solubility avoiding all hardness-related problems.

Therefore, when water gets softened, its sodium level increases.

Further information on this procedure can be found in 'Section 2.8'.

ION EXCHANGE RESINS:

They are synthetic compounds, usually with an spherical shape, able to capture certain chemical substances present in water, which then exchanges for other substances. Water softening uses strong cation resins, which are composed of styrene copolymers and divinylbenzene with a sulphur base.

The exchange resin charge is inside the column of the water softener and takes up a significant part of the total volume (between 60 and 75%, according to each model). A part of the column must remain empty, in order to allow for a proper regeneration of the resin bed.

During the treatment process, water goes into the multi-way valve through the inlet connection, flows towards the upper part of the tank through the top nozzle and goes downwards through the bed resin, thus producing the ion exchange.

Treated water is collected by the bottom nozzle and led to the multi-way valve through the inner tube of the tank. Treated water is sent for consumption using the outlet connection. At this point, the system has a treated water meter in order to measure the water volume.

2.3 Regeneration of the System

Sal
NaCl

The quantity of calcium and magnesium ions that the resin may retain is limited; therefore, the water volume a water softener can treat is limited as well.

The system must periodically carry out a process known as regeneration, which allows the resin to recharge with sodium ions, so it can continue softening water.

In STRATOS systems, the regeneration process starts automatically when the configured water volume is achieved. The programmer allows the user to set several regeneration start modes (see 'Section 6.3' to obtain further information how to operate the programmer).

The regeneration of a softener system is composed of several stages, which are described below:

BACKWASH:

Water comes into the column through the lower manifold, washing the suspended matter and fluffing the resin bed up, thus facilitating the subsequent regeneration process.

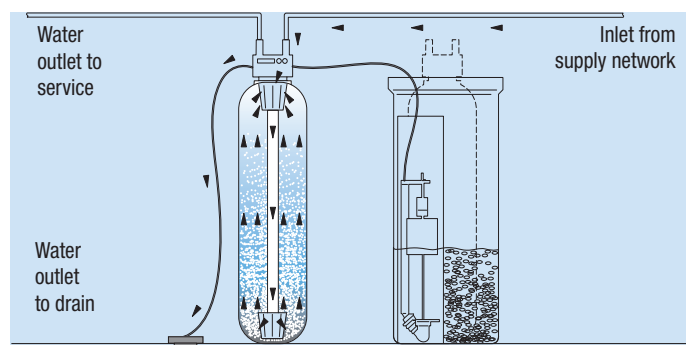

BRINE ASPIRATION:

By means of an aspiration process relying on a Venturi effect, the system sucks the brine solution, which has previously been prepared in the regenerating tank. This brine solution is introduced downwards in the softening column, gets in contact with the ion exchange resin and regenerates it.

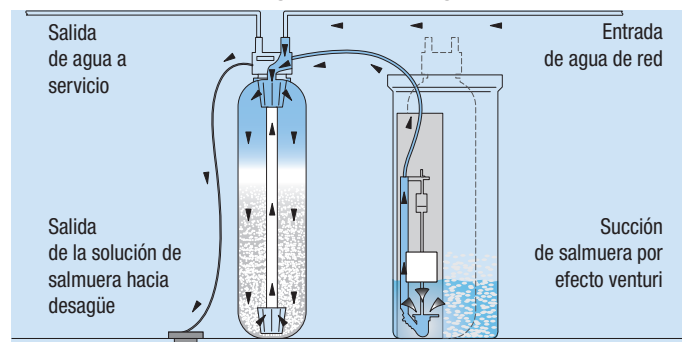

SLOW WASH:

In this stage the brine solution, which has been previously sucked up, goes through the resin bed. Throughout this process, the contact between the brine and the resin is complete, which optimizes the regeneration.

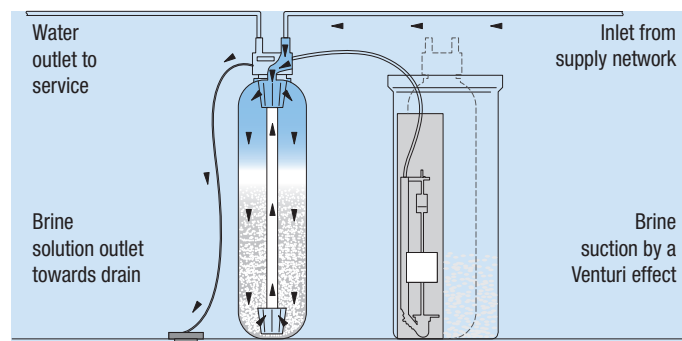

QUICK WASH:

Washing water goes downwards through the resin bed, getting it settled and ensuring the complete removal of the brine, which might remain inside the bottle.

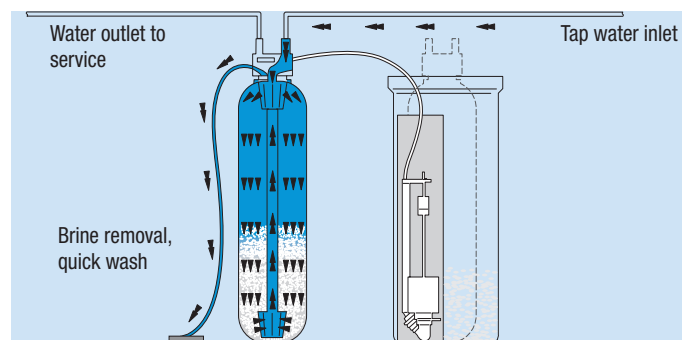

TANK FILLING:

The necessary water volume is sent to the brine tank in order to prepare the same amount of consumed brine for the next regeneration process. This process is fully automatic, thus it is not necessary to add any water to the brine tank (except during the start-up, as indicated in 'Section 7').

NOTE: During the regeneration process, the systems may allow untreated water to go through, in order to guarantee the water supply.

2.4 Regeneration Degree and Capacity



The exchange capacity is the quantity of hardness that a certain resin volume can retain before getting exhausted. This value is usually expressed as °HFxm³/litre.

The higher the resin volume of the system is, the higher will be the quantity of hardness that can be retained before the resin gets exhausted. It is very important to choose the appropriate system for each type of installation.

Depending on the quantity of sodium chloride used to regenerate each litre of resin, the exchange capacity of the resin may change.

STRATOS softeners have six different regeneration degrees, depending on the conditions in which the system must work (for further information, please read 'Section 3').

Systems are supplied as a standard with a regenerating degree of 80g NaCl/litre of resin, which is appropriate to work up to the maximum hardness indicated below:

MODEL	Salt consumption	Maximum hardness
STRATOS 15	1.2 Kg (80g/ltr)	45°HF
STRATOS 25	2 Kg (80g/ltr)	70°HF

2.5 Working Flows



Water softeners working by means of an ion exchange must respect certain contact periods between water to be treated and resin, in order to ensure that the softening process is carried out properly. For STRATOS softeners the working ranges indicated below must be respected:

Minimum flow (litres/hour): Resin volume x 4

Maximum flow (litres/hour): Resin volume x 40

Should working ranges be outside the recommended ranges, the proper operation of the system could be affected (excessive loss of charge, hardness leakage, etc.)

For further information on the minimum and maximum flows for each softener, please check the general specifications table.

2.6 Hardness Leakage

The ion exchange process on which water softening is based may be affected by different factors, which can reduce its efficiency, thus causing a certain level of hardness leakage.

ELEVADA CONCENTRACIÓN DE SODIO EN EL AGUA A TRATAR

It may interfere in the exchange process.

OVERFLOW

Since there is not enough contact time, some of the hardness may not be retained by the resin.

REGENERATION DEGREE

The higher the regeneration level is, the lower is the risk of a hardness leakage.

2.7 Residual Hardness

Depending on the final use of treated water, it may be necessary to obtain fully softened water or, on the contrary, it may be desirable to leave some residual hardness.

These systems have been designed to supply fully softened water, but the control valve integrates a residual hardness mixer, which allows for the regulation of the desired hardness degree in treated water (see 'Section 7').

Note: In water for human consumption it is recommended to have a residual hardness between 5 and 8 °HF if pipes are made of copper, and between 8 and 10 °HF if they are made of iron (for the latter, it is also recommended to install a silicopolyphosphates filter afterwards).

2.8 Sodium Increase

Most of the sodium we consume on a daily basis comes from food, specially processed food, since salt is an excellent preservative and is used as an additive in prepared products.

Sodium consumption through the water we drink is rather low when compared with that obtained from food.

In spite of this, it is very important to bear in mind, as mentioned above, that water softeners increase the sodium concentration present in treated water when compared to the concentration measured on the inlet.

WARNING: The maximum recommended sodium level in water for human consumption is of 200 ppm. Depending on the sodium concentration and the hardness of water to be treated, it is possible that softened water contains a higher concentration of sodium than recommended. Should this be the case, or if water is to be consumed by persons who must follow a low sodium diet, it is recommended to install a household reverse osmosis system in order to be able to drink the water.



The table below can be used as a guideline to know the increase on sodium concentration in treated water depending on the inlet hardness:

INITIAL HARDNESS IN WATER °HF)	SODIUM ADDED BY THE SOFTE- NER (mgNa/litre)
10	43
15	65
25	108
30	130
35	152
40	173
45	195
50	217
60	260

3. TECHNICAL DATA FOR THE STRATOS MODEL

Model	STRATOS 15	STRATOS 25
Code	795113	795224
Resin volume	15 Litres	25 Litres
Working flow	1,2	1.8
Maximum flow	1,0	1.6
Regeneration 80 g/L		
Salt/regeneration	1.2 Kg	2.0 Kg
Exchange capacity	61°HFxm ³	102°HFxm ³
Backwash	3 min	6 min
Counterflow	3.3 min	2.7 min
Quick rinsing	3 min	6 min
Brine Aspiration	40 min	49 min
Regeneration 120 g/L		
Salt/regeneration	1.8 Kg	3.0 Kg
Exchange capacity	75°HFxm ³	122°HFxm ³
Backwash	3 min	6 min
Counterflow	5 min	4.2 min
Quick rinsing	3 min	6 min
Brine Aspiration	43 min	52 min
Regeneration*		
Salt/regeneration	*200g/L: 3,0 Kg	*250g/L: 6,25 Kg
Exchange capacity	90°HFxm ³	175°HFxm ³
Backwash	3 min	6 min
Counterflow	8,3 min	8,7 min
Quick rinsing	3 min	6 min
Brine Aspiration	49 min	64 min
Dimensions		
Height: A	900	1130
Width: B	335	335
Depth: C	570	570

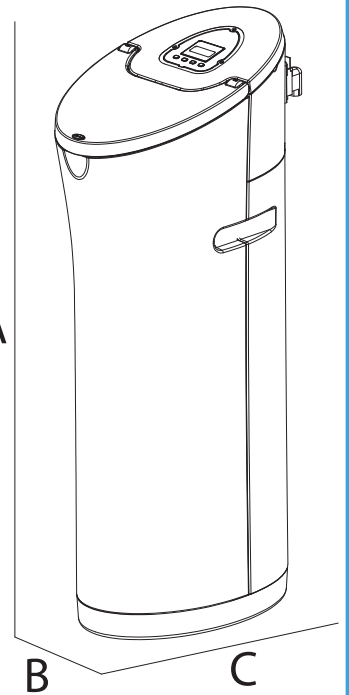

VOLUME OF TREATED WATER ACCORDING TO INLET HARDNESS

STRATOS 15 (795113)

STRATOS 25 (795224)

Inlet hardness	STRATOS 15 (795113)			Inlet hardness	STRATOS 25 (795224)		
	(61°HFxm ³)	(75°HFxm ³)	(90°HFxm ³)		(102°HFxm ³)	(122°HFxm ³)	(175°HFxm ³)
15°HF	4.06 m ³	5.00 m ³	6.00 m ³	15°HF	6.80 m ³	8.13 m ³	11.66 m ³
20°HF	3.05 m ³	3.55 m ³	4.50 m ³	20°HF	5.10 m ³	6.10 m ³	8.75 m ³
25°HF	2.44 m ³	3.00 m ³	3.60 m ³	25°HF	4.08 m ³	4.88 m ³	7.00 m ³
30°HF	2.03 m ³	2.50 m ³	3.00 m ³	30°HF	3.40 m ³	4.06 m ³	5.83 m ³
35°HF	1.74 m ³	2.14 m ³	2.57 m ³	35°HF	2.91 m ³	3.49 m ³	5.00 m ³
40°HF	1.53 m ³	1.88 m ³	2.25 m ³	40°HF	2.55 m ³	3.05 m ³	4.38 m ³
45°HF	1.36 m ³	1.67 m ³	2.00 m ³	45°HF	2.27 m ³	2.71 m ³	3.89 m ³
50°HF	1.22 m ³	1.50 m ³	1.80 m ³	50°HF	2.04 m ³	2.44 m ³	3.50 m ³
55°HF	1.11 m ³	1.36 m ³	1.64 m ³	55°HF	1.85 m ³	2.22 m ³	3.18 m ³
60°HF	1.02 m ³	1.25 m ³	1.50 m ³	60°HF	1.70 m ³	2.03 m ³	2.92 m ³

4. UNPACKING AND VERIFICATION OF THE CONTENTS

It is important that prior to installing and starting the system you check the received materials, with the aim of guaranteeing that it has not been damaged during transport.

Any claims for damages during transport must be presented together with the delivery note or invoice to the distributor, including the name of the carrier, within a period of 24 hours following the reception of goods.

All systems are supplied fully assembled and are composed of the elements below:

- Metered STRATOS H.E. valve. It is fully automatic and made of Noryl. It has a built-in isolation by-pass and a mixing valve for residual hardness.
- Bottle containing resin made of reinforced polyethylene with glass fibre.
- The strong cation ion exchange resin, specially made for softening, is supplied inside the bottle.
- Compact STRATOS cabinet, made of plastic, which can contain enough salt for several regenerations.
- Brine suction system.
- Packaging and protections, including a pressurised air balloon to prevent the bottle from moving.

Before starting the installation of the system, please read this manual carefully.

! The air balloon must be removed before starting the installation.

The packaging materials can be recycled and must be thrown away in the appropriate selective recycling bins or the specific centre for the Collection of waste material.

The machine that you have acquired has been designed and manufactured with high quality materials and components that can be recycled and reused. This product must not be

thrown away into the usual urban rubbish bins. When you want to throw the machine away, it must be taken to a specific local centre for the collection of materials, stating that it has circuits, and electric and electronic components, as well as ion exchange resin.

In order to obtain more information about how to dispose of your electrical and electronic machine once they have fulfilled their use, contact the management of urban waste service or the establishment in which you acquired the system.

The proper collection and treatment of the machines that can no longer be used contributes to the preservation of natural resources and also to avoiding potential public health risks.

5. PREVIOUS WARNINGS



! STRATOS water treatment systems ARE NOT POTABLE WATER SYSTEMS.

! Should the water to be treated not come from a public water supply, that is, from an unknown source, a physical-chemical and bacterial analysis of the water shall be necessary, with the aim of ensuring its proper purification applying the proper techniques and systems appropriate to each case, PRIOR TO THE INSTALLATION of the system.

! Contact your distributor in order to obtain advice about the most appropriate treatment for you.

5.1 Conditions for the proper operation of the system



- Do not use hot water in the system ($T < 36^{\circ}\text{C}$).
- The room temperature must be between 4°C and 45°C .
- The system should be installed in a dry environment, free of acid vapours. Otherwise, please ensure a proper ventilation.
- A minimum pressure of 2.5 bars must be ensured. Should this minimum pressure not be available, a pressure system shall be installed.

- If inlet pressure is higher than 5.5 bars, a pressure regulator must be installed.

- Water to be treated must be properly filtered, therefore, it is recommended to install a pre-filter to guarantee the removal of suspended particles, which may be swept along by inlet water. It is recommended to use **FILTERMAX self-cleaning filters**. Please contact your distributor for further information.

! Failure to install an appropriate filter would result in particles obstructing the inner holes or injectors of the system, thus affecting its proper operation. .

5.2 Installation of the system



- If the water softener must treat all the water supply of your home, connect it to the general supply pipe before connecting the rest of pipes, except for pipes supplying the outside. Taps located outside the house must supply hard water. Due to the sodium increase in softened water, it is not recommended to use it for watering, since it can negatively affect the growth of plants and vegetables.

- Should it be necessary to condition the installation of the home in order to install the system in the foreseen location, it must be carried out in accordance with the national regulations in force, concerning internal electric and hydraulic installations.

- The planned location for the installation must have enough space for the system itself, its accessories, connections, and to carry out a proper maintenance.

- The system should not be installed next to a heat source or where it receives a direct flow of hot air.

- The drain connection, where water from regeneration will be driven, must be underneath the installation if possible. Drain connection must always have a free outlet. The diameter of this connection must have a minimum size of 1". The maximum distance between the water softener and the drain intake cannot be placed higher than 6 m.

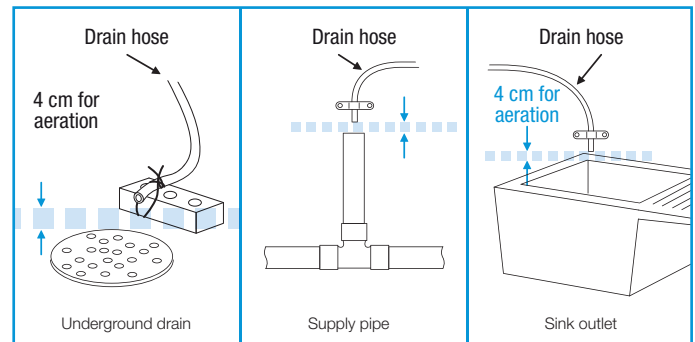

- The surroundings and the environment where the system and faucet are to be installed must meet the appropriate hygienic and sanitary conditions.

- Avoid external drips from pipes, drains, etc. onto the system.

- Under no circumstances must the system be installed on the outside.

- Should softened water be supplied to a hot water or vapour generator, it will be necessary to install a dependable check valve between the water softener and the generator, in order to prevent hot water from returning to the system and damaging it.

- It is recommended to install some valves for sample taking both for treated and untreated water, as close as possible to the water softener.

- If there are quick-closing valves, it is recommended to install a device to prevent water hammers.

- The water softener only works with a power supply of 12 volts – 50 herz, which comes from the transformer included in the system. Please make sure that the transformer is used and that it is connected to a power supply of 220 – 240 V, 50Hz. Also, it must be ensured that the electrical installation of the house is properly protected by a circuit breaker or a fuse.

- If daytime pressure is higher than 5.5 bars, night-time pressure may exceed the maximum. Please use the pressure-reducing valve if necessary. (a pressure-reducing valve may reduce the flow).

- It is recommended to install a silicopolyphosphates filter in the system's outlet to protect the pipes from the corrosion of softened water.

5.3 Start-up and maintenance



- The system must be hygienised periodically. See 'Section 8' for further information.
- Maintenance must be carried out by qualified technical personnel, under the proper hygienic conditions. (For further information contact the technical service of your distributor.)

6. INSTALLATION OF THE SYSTEM



The installation of the water softener must be carried out by skilled technical personnel. Follow the recommendations in 'Section 5' Previous warnings of this manual.

Given that the system that you are going to install improves the quality of the water you consume and is considered a food, all of the tools that you are going to use for the assembly and installation must be clean and, under no circumstances, contaminated or impregnated with grease, oils or rust. Please be extremely careful when handling the materials that are going to be in contact with treated or untreated water. (For further information contact your distributor.)

6.1 Required Tools and Pieces

Before starting the installation, please take all the necessary tools and follow the instructions included in 'Section 6.2'.

IF WELDED COPPER PIPES ARE USED

Tube-cutter
Blowtorch
Clamps
Tin-Silver
Sandpaper or steel wool

IF THREADED PIPES ARE USED

Pipe-cutter or steel saw
Thread rolling machine
Sealing paste for pipes
Clamps

IF CPVC PLASTIC IS USED

Pipe-cutter
Steel saw
Adjustable wrench
Glue for PVC

Clamps

IF ANY OTHER MATERIAL IS USED

Other appropriate pipes and fasteners for drinking water supply, according to the requirements from the manufacturer and the local regulations.

6.2 Step-by-Step Installation

1. The system must always be installed with the supplied by-pass valve. Additionally, a three-valve by-pass can be installed. The by-pass of the STRATOS systems has several positions.

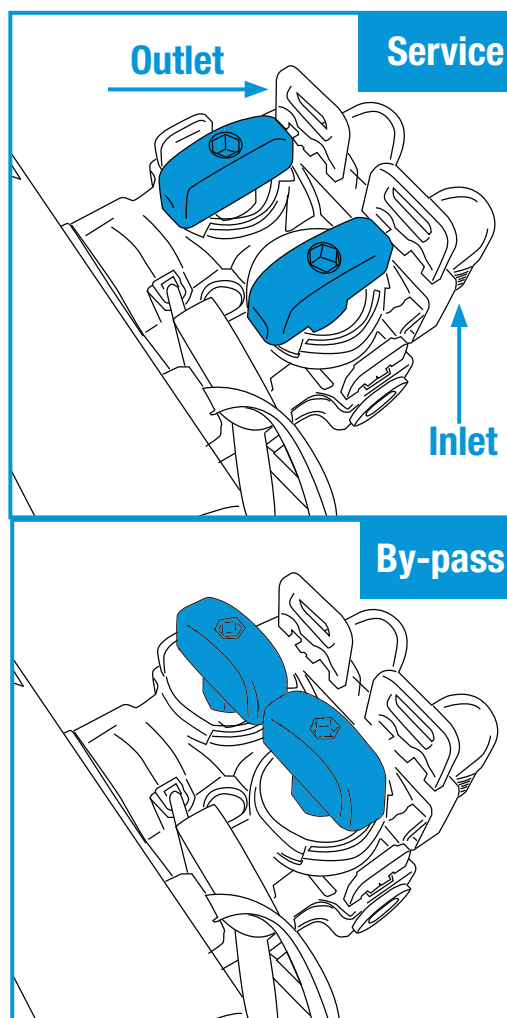

RECOMMENDED INSTALLATION

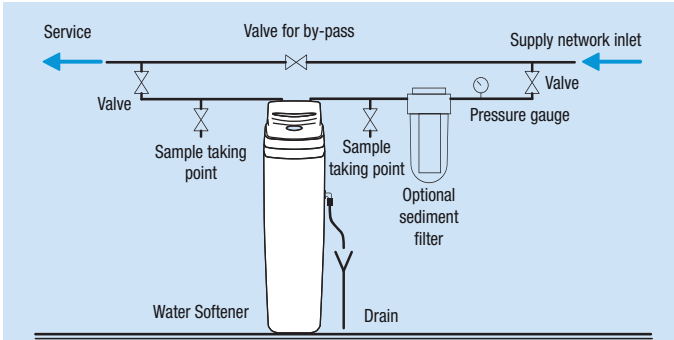

2. Close the general water supply valve, which should be next to the main pump or the water-meter.

3. Open all taps in order to empty the pipes from all water.

NOTE: Make sure that the heater is not emptied, in order to prevent any damages on it.

! DANGER There is a danger of injury due to an excess of weight. It is necessary that at least two persons move and install the system, as well as move and rise the salt bags. There is a danger of suffering back injuries and other body injuries.

4. Move the water softener towards the installation place. Place it on an even surface. If necessary, place it on a plywood platform at least 2 cm thick. Then, level the platform using a wedge.

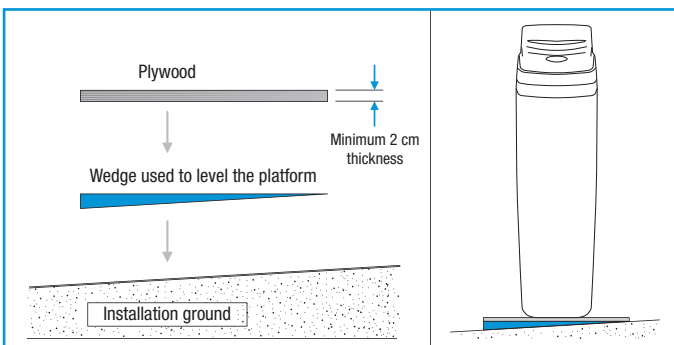

! IMPORTANT: Do not place the wedges directly underneath the salt tank. The weight of the tank filled with water and salt may cause the tank to break against the wedge.

5. First make a visual check and clean the inlet and outlet connections of the softener to remove any residues.

6. The system is supplied with a set of inlet and outlet connections. Please make sure that fastening clips are tightened on the connectors.

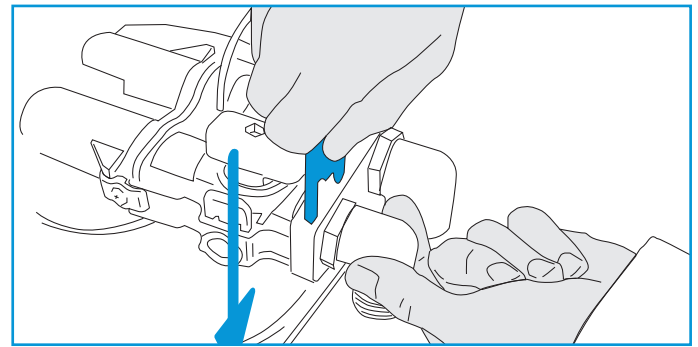

7. The tubes and accessories used to connect the main supply pipe to the inlet and outlet of the water softener valve must be loosely measured, cut and assembled.

Please keep all fastenings, joints and tubes centred and straight. Check that water flows from the pipe towards the inlet of the water softener.

NOTE: The inlet and outlet are indicated in the valve. Draw the sense of the flow to be sure.

! IMPORTANT: Check that the pipes are fixed, aligned and leaned on something in order to avoid any pressures on the inlet and outlet of the water softener. A wrong pressure coming from a misaligned pipe, or which has not enough place to lean on, could damage the valve.

WELDED COPPER

1. Carefully clean and apply welding paste on all joints.

2. Carry out all the welding.

NOTE: Do not weld to the installation the pipes of the by-pass valve. The heat from the welding could damage the valve.

! IMPORTANT: In order to install the copper pipes and assemble the earth-grounding clamp, this must be already fastened. It is necessary to screw on this piece.

THREADED PIPE

1. Apply a sealing paste for pipes or Teflon tape on all male threaded pipes.
2. Tighten all threaded connections.

CPVC PLASTIC PIPE

1. Clean, prepare and glue all joints according to the manufacturer's instructions.

OTHER

Please follow the instructions from the pipes' manufacturer when using other types of pipes and fixtures approved for drinking water.

INSTALLATION OF THE DRAIN

Measure and cut the necessary length, and then connect the drain line of ½" to the accessory for the drain connection of the water softener. Fasten the hose with a clamp.

NOTE: Hook the hose of the drain to the underground drain. Tighten the drain hose. This will prevent any pipe whip during regenerations.

HOW TO INSTALL THE ELBOW OF THE OVERFLOW DRAIN OF THE SALT TANK

Connect the overflow drain elbow from the system to a near drain. This drain intake must be at a lower height than the overflow drain.

NOTE: The overflow hose must be installed in such way that water cannot return from the drain hose.

6.3 STRATOS Programmer



DESCRIPTION OF THE PROGRAMMER

All systems have a built-in state-of-the-art electronic programmer with a multicolour interactive display. This advanced controller allows to fully monitor the operation of the system. The display is installed on the upper part of the compact cabinet.

This programmers will provide you with information concerning the operation of the system, as well as allowing you to set up all parameters.

MAIN FEATURES:

- User-friendly and intuitive programming.
- Multicolour interactive digital display.
- Holiday Mode
- Here the desired regeneration can be chosen by time, delayed, immediate or mixed.

MULTICOLOUR LCD DISPLAY: It shows the information concerning the state of the system. Depending on each moment, the display will show different types of messages:

Service: It offers information concerning the operation of the system.

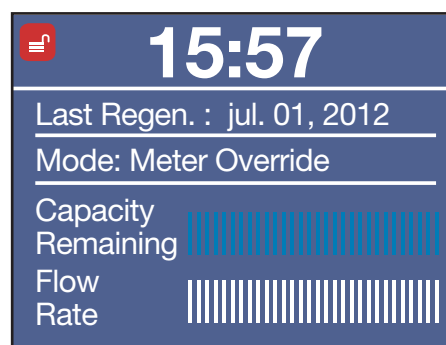

Regeneration: It shows the regeneration stage of the system and the remaining time. It shows as well the current time.

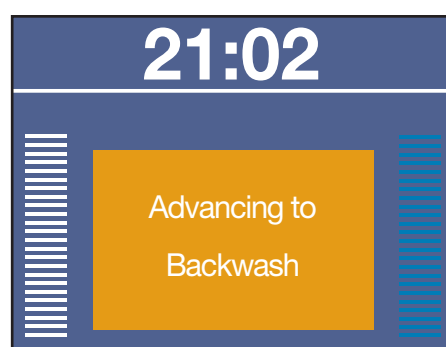

Programming: It shows the internal parameters and allows its modification.

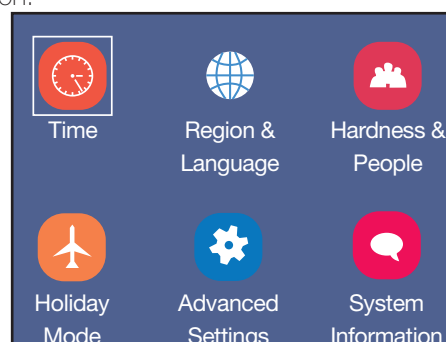

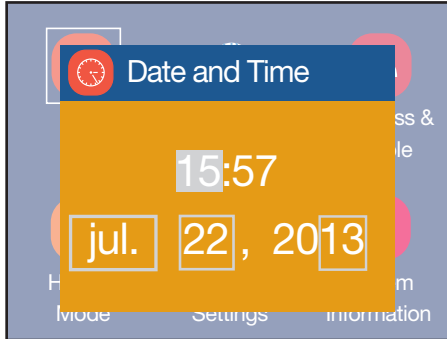

! **IMPORTANT:** When connecting the system the following message may appear:

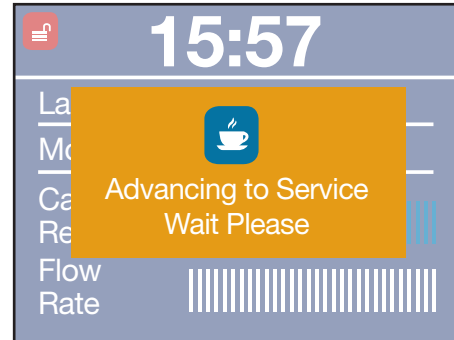

'MENU' BUTTON: Press this button to go to the menus and sub-menus. Once inside, you can go back through the programming process.

'SET/REGEN' BUTTON: Press this button to trigger immediate or delayed regenerations. When programming, it allows to select the parameter as well as to confirm it.

'+ and -' BUTTON: Press this button to select and modify the parameter.

HOW TO LOCK THE PROGRAMMER: : If no button is pressed during certain time, the programmer gets locked for security reasons, and shows the message below when any button is pressed.

This means that the system is entering the service mode. If two minutes have gone by, and this message is still showing, please contact your distributor.

2. Press the 'MENU' button for 3 seconds to get into the internal program of the system. At this point you may have access to the following parameters:

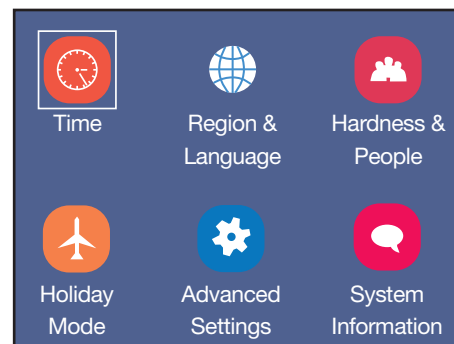
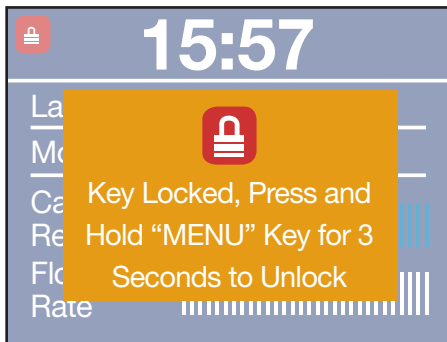

To unlock the programmer, press the 'MENU' button during 3 seconds.

 **Time:** The current date and time can be configured.

6.4 How to Program the System

STRATOS systems are configured to carry out delayed regenerations at 2 a.m.

USER PROGRAMMING:

1. Connect the supplied transformer with the electrical connector located on the rear part of the system. The programmer must be in service and show a message similar to that in the previous section.

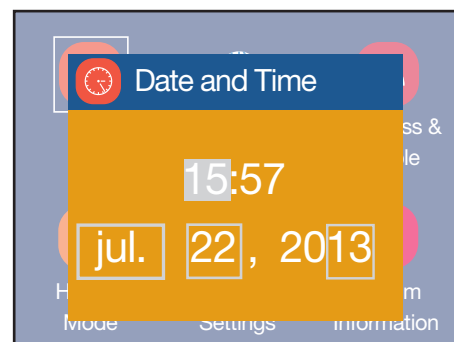

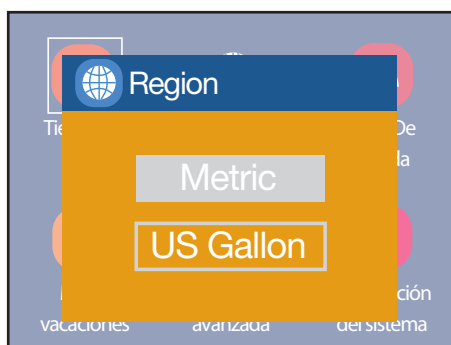

 **Miscellany:** Here the following parameters can be selected:

1. Units of measure, in the metric or American system. It is supplied by default in the metric system.

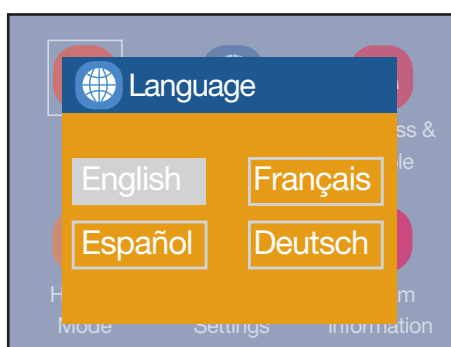

2. Language: There are three languages available: Spanish, English, French, German. It is supplied by default in Spanish.



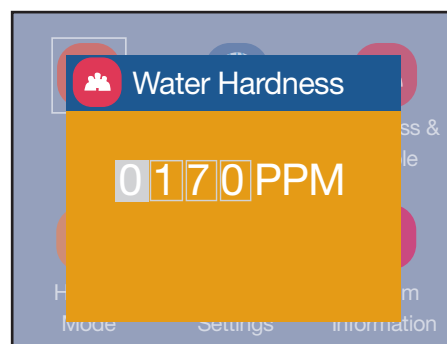
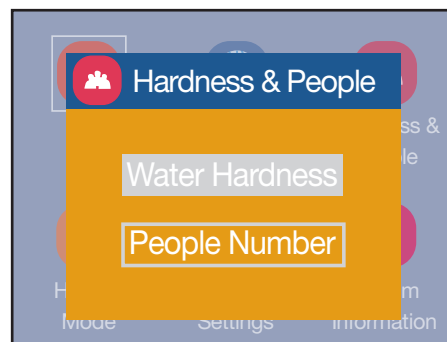

 **Input data:** It must be programmed.

1. Hardness: Inlet water hardness in ppm of CaCO₃ (°HFx10).

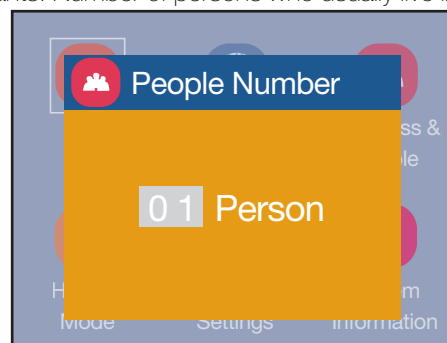

2. Inhabitants: Number of persons who usually live in the home.



 **Holiday Mode:** Here the user can set when there will be nobody at home for a long period of time.

During this period, the system will carry out small washes without consuming salt, in order to prevent water from stagnating inside the system.

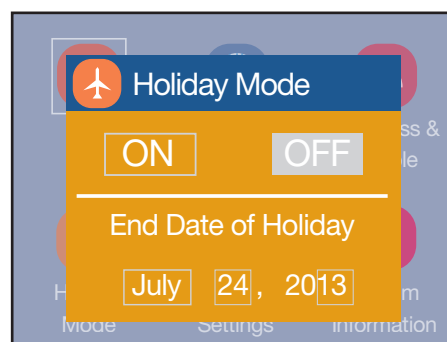



System information: This feature delivers information on the water softener:

- Total number of regenerations.
- Total volume of treated water.
- Regeneration hour.
- Volume of treated water between each regeneration.
- Safety regeneration frequency.
- Length of the regeneration stages.
- Current flow.
- Maximum registered peak flow.
- Software version.

ADVANCED PROGRAMMING (ONLY FOR PROFESSIONAL USE):

This internal level is only intended for the Technical Service and is password protected. Under no circumstances should the programmed parameters be modified without checking previously with the Technical Service of the dealer.

HOW TO START A REGENERATION:

STRATOS water softeners allow you to program both delayed or immediate regenerations. On this purpose, press the 'REGEN' button for 3 seconds to get into the menu below:

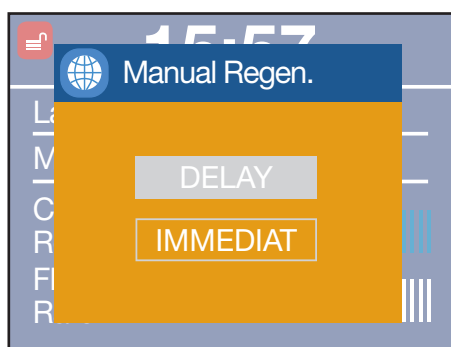

By pressing the 'SET/REGEN' button, the user can select the type of regeneration and with the 'MENU' button, the user can trigger the regeneration.

HOW TO MOVE THE REGENERATION FORWARD:

Once the regeneration has started, the user can move forward to the next stage by cancelling the current one. On this purpose, just press any of the buttons on the programmer. This function will be disabled during the time in which the motor is moving forward to the next stage.



7.1 Hydraulic Start-up

Before starting the system up, please check that all steps previous to installation, assembly and programming have been properly followed, according to this instructions' manual, as well as the regulations in force. To start the system up, please follow the instructions below:

! Do not charge the system with salt until the end of the start-up. In order to prevent any air pressure on the water softener and the pipes, please follow these instructions in order.

1. Place the by-pass valve on the 'service' mode.
2. Fully open two or more cold and treated water faucets located near the water softener.
3. Plug the programmer to the power supply using the transformer included in the system.
4. The program must be in 'service', otherwise please check 'Section 6.3'.
5. Press the 'REGEN' button for 3 seconds to start a regeneration. Now you are inside the regeneration menu. Select the immediate regeneration. After some minutes, the system will move to the Backwash stage.
6. Slowly open the water inlet valve to allow the entrance of water inside the system. At this point, the inlet flow must be rather low, since in this position water will come in from the bottom of the bottle and flow upwards to the drain.
7. When water starts flowing continuously through the drain, fully open the water inlet of the system. At this point, the bottle will be full of water and so a higher flow will not produce any damage. Water going out to the drain may be a bit yellowish or brown. This is completely normal, since it is due to the preservatives of the resin.
8. Let the water flow through the drain until it runs clear.
9. Close the water supply to the system for five minutes, so the resin can settle down the bottom of the bottle, and the air that might be left inside can flow towards the upper part of the bottle.
10. Open the inlet valve of the system and wait for some mi-

minutes in order to make sure that the remaining air has been purged.

11. Cancel the current regeneration stage and move forward to the filling stage of the tank. Now the brine tank will automatically start to fill up with water. Let this stage run the full process. At the end of the stage, the system will finish the regeneration which was started in point 6.

12. Start another regeneration according to point 6 and wait until the system reaches the Backwash stage. Press any button to move forward to the Brine suction stage.

13. The system should suck water from the brine tank. Let the suction work for some minutes just to make sure that it is working properly.

14. Cancel all the remaining stages of the regeneration.

15. Put the by-pass in the service mode and check that treated water is properly softened (see 'Section 7.3').

16. Charge the brine tank with salt.

17. The system is ready to operate.

! 'DANGER' There is a danger of injury due to an excess of weight. It is necessary that at least two persons move and rise the salt bags. There is a danger of suffering back injuries and other body injuries.

7.2 Residual Hardness Regulation

As mentioned in 'Section 2.7', it is not recommended to supply completely softened water to household supplies.

In order to modify the residual hardness, lightly open the regulating valve, as indicated in the image below.

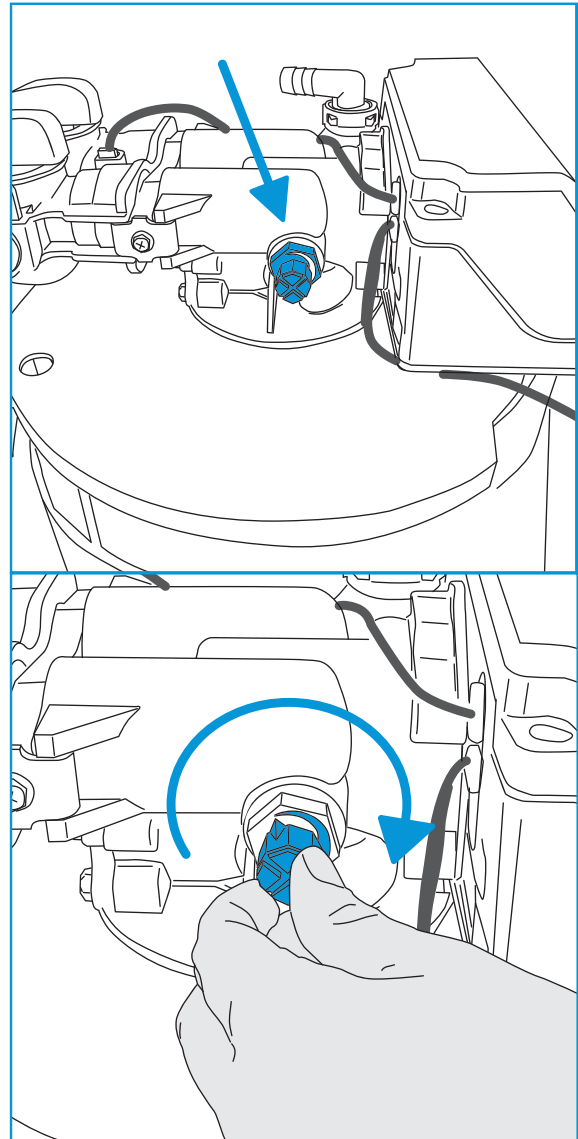

Then measure the water hardness present on the outlet of the system and check that it fits within the desired values. Otherwise, adjust the regulator and check again.

! **WARNING:** The hardness regulator is supplied in the closed position, therefore, if the system is not adjusted, it will supply fully softened water.

7.3 How to Check Hardness



To measure water hardness with the analyser (code 271800) follow the instructions below:

1. Fill the clear recipient with the water you want to analyse until the checkmark.

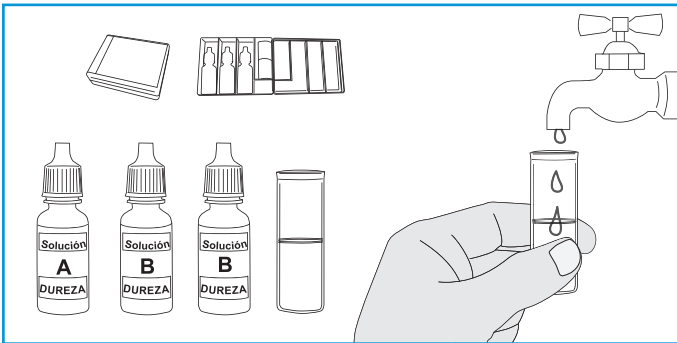

2. Add two drops of A reagent and shake carefully.

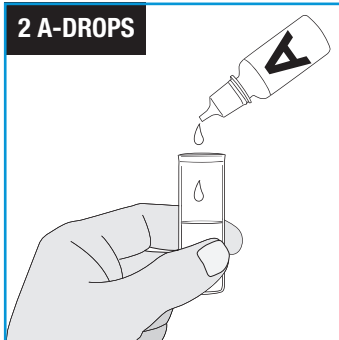

3. If the sample turns blue, it means that water is fully softened, but if it keeps a red colour, it means it has some hardness.

4. Slowly add more drops of B reagent until water turns blue. The quantity of used drops corresponds to the hardness in °HF of the sample.



8. MAINTENANCE AND HYGIENISATION



In order to guarantee the proper operation of the system, the following verifications must be carried out as frequently as indicated:

VERIFICATION	FREQUENCY
Check the salt level in the tank:	Monthly.
Check inlet hardness:	Monthly.
Check treated water hardness:	Monthly.
Hygienisation:	Yearly.
Anti-scaling:	Yearly.
Cleaning the salt tank:	Yearly.
Technical Service verification:	Yearly.



It is very important to carry out the hygienisation and anti-scaling tasks separately, since the chemical products used for this purpose could have a bad reaction when mixed. The hygienisation and anti-scaling tasks must be carried out by turns, according to the indicated frequency.

SALT FILLING

The salt level in the tank must be frequently checked. The minimum salt level must be kept, which corresponds to a third of the tank volume. If salt runs down before filling it up again, the system will produce hard water. After the verification, check that the salt deck is properly closed.

NOTE: For humid areas, it is recommended to keep a lower salt level, filling it up more frequently.

RECOMMENDED SALT: Thick salt in tablets or balls containing less than 1% of impurities.

NOT RECOMMENDED SALTS: Salt stones, salt with impurities, in blocks, granulated, in bars, or that used to cook.

HOW TO BREAK A SALT BRIDGE

Sometimes a salt bridge can get formed inside the salt tank. This is due to a high level of humidity or to the use of an inappropriate salt. When there is a salt bridge, there is an empty space left between water and salt which prevents it from dissolving. This means that the water softener will not regenerate properly and supply hard water.

8. Maintenance / Hygienisation

If the tank is full of salt it is difficult to know whether there is a salt bridge, since the salt on the surface may seem loose, even if the lower part is solid.

In order to check the existence of a salt bridge, take a long rigid tool (e.g. a broom handle) and keep it next to the water softener to measure the distance from the floor up to the salt edge. Then put the tool in the salt. If there is a hard object, it may be a salt bridge.

Apply carefully some pressure on several places until it breaks.

! **'WARNING'** Do not use sharp or pointed objects, since they could damage the water softener tank.

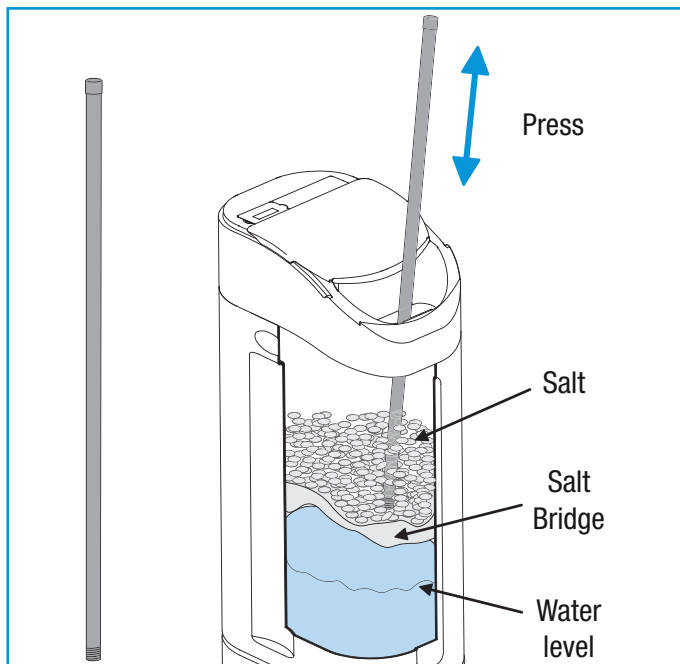

HYGIENISATION: It is recommended to carry out an hygienisation process once per year, as indicated below:

1. Open the deck of the salt tank and pour between 20 to 30 ml (2 or 3 caps) of Bacwater (652100) inside the brine chimney. Close it again.
2. Check that the by-pass valve is in service.
3. The disinfection process will be carried out after the regeneration and the disinfecting solution will be sent to the drain.

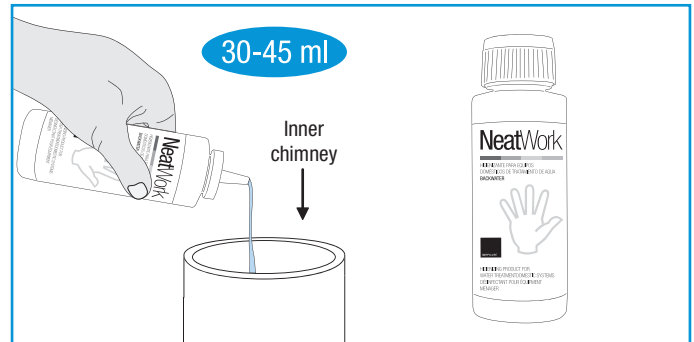

ANTI-SCALING: Once per year it is recommended to clean the water softener with Clean Softener (611000). This product has been designed to clean and descale your water softener. This product, due to its special formula, cleans the resin by removing iron residues and other metals which might pollute it. It also removes possible scaling on the inner holes of the valves.

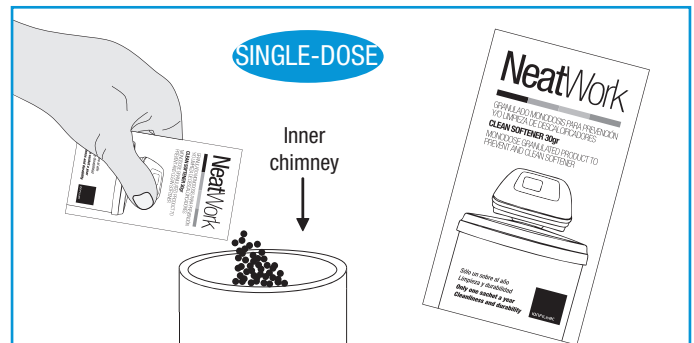

NOTE: Carefully follow the instructions for use provided on the labels of the product.

The maintenance and hygienisation of the system must be carried out by skilled technical personnel under the proper hygienic conditions and following the specific instructions of each product.

9. GUIDE FOR THE IDENTIFICATION AND SOLUTION OF PROBLEMS

PROBLEM		SOLUTION
1. The programmer is not working	1. The transformer is not plugged.	1. Plug the transformer to a power supply.
	2. Faulty electrical wire.	2. Replace the wire.
	3. There is no power supply.	3. Check the installation.
	4. Transformer is faulty.	4. Replace the transformer.
2. The system does not regenerate when scheduled	Power interruptions are modifying the schedule.	Follow the instructions provided in this manual to set the clock.
3. Water leaks	Connections are loose.	Tighten the connections.
4. Annoying noises / White water	Air inside the system.	Carry out an additional backwash to purge the air.
5. High level of hardness in treated water	1. Hardness in inlet water has increased.	1. Analyse the hardness and program the system again.
	2. Wrong regeneration.	2. Check the programming.
	3. Resin is damaged.	3. Replace the resin.
	4. There is no salt in the tank/salt bridge.	4. Add salt in the system or break the salt bridge.
6. There is no brine suction	1. Not enough pressure at inlet.	1. Inlet pressure must be at least 2.5 bars.
	2. Brine line is blocked.	2. Clean the brine line.
	3. Injectors are blocked.	3. Clean or replace the injector and the filter.
	4. Internal water leaks.	4. Check the piston, joints and separators.
7. The brine tank overflows	1. Forwarding time is not correct.	1. Please contact your dealer.
	2. Suction is not correct.	2. Check the suction.
	3. Forwarding flow is too high.	3. Check the forwarding pipes.
8. Hardness is not being removed from water	1. Failure to start a regeneration.	1. Check the power supply of the system.
	2. There is not enough brine concentration.	2. Keep the brine tank full of salt.
	3. Suction is not correct.	3. Check the suction.
9. Backwash flow is too high or too low	1. Backwash regulator is not correct.	1. Install an appropriate regulator.
	2. Backwash regulator is blocked.	2. Clean the backwash regulator.
10. There are leaks of untreated water during service	1. Wrong regeneration.	1. Carry out a regeneration ensuring that salt is properly adjusted.
	2. There are leaks in the by-pass valve.	2. Check the by-pass valve.
	3. O-ring of the nozzle tube damaged.	3. Replace the o-ring.
	4. Regeneration cycle is not correct.	4. Reset the regeneration cycle.
11. Resin leakage from the system	1. Inner diffusers are damaged.	1. Replace inner diffusers.
	2. Resin is damaged.	2. Replace the resin and check the installation.
12. Water flows through the drain during service	1. Joints and separators are damaged.	1. Replace the joints and separators.
	2. Piston is damaged.	2. Replace the piston.
	3. Piston is not properly set.	3. Restart the system and repeat the process. If problem persists, please contact your dealer.

NAME, SIGNATURE AND STAMP OF AUTHORISED TECHNICIAN				
/	/	<input type="checkbox"/> START-UP	TECHNICIAN	<input type="checkbox"/> ORDINARY <input type="checkbox"/> EXTRAORDINARY <input type="checkbox"/> GUARANTEE
/	/	<input type="checkbox"/> COMPLETE MAINTENANCE	STAMP	
/	/	<input type="checkbox"/> REPAIR		
/	/	<input type="checkbox"/> HYGIENISATION		
/	/	<input type="checkbox"/> OTHER		
/	/	<input type="checkbox"/> COMPLETE MAINTENANCE	TECHNICIAN	<input type="checkbox"/> ORDINARY <input type="checkbox"/> EXTRAORDINARY <input type="checkbox"/> GUARANTEE
/	/	<input type="checkbox"/> REPAIR	STAMP	
/	/	<input type="checkbox"/> HYGIENISATION		
/	/	<input type="checkbox"/> OTHER		
/	/	<input type="checkbox"/> COMPLETE MAINTENANCE		
/	/	<input type="checkbox"/> REPAIR	STAMP	
/	/	<input type="checkbox"/> HYGIENISATION		
/	/	<input type="checkbox"/> OTHER		
/	/	<input type="checkbox"/> COMPLETE MAINTENANCE		TECHNICIAN
/	/	<input type="checkbox"/> REPAIR	STAMP	
/	/	<input type="checkbox"/> HYGIENISATION		
/	/	<input type="checkbox"/> OTHER		
/	/	<input type="checkbox"/> COMPLETE MAINTENANCE		TECHNICIAN
/	/	<input type="checkbox"/> REPAIR	STAMP	
/	/	<input type="checkbox"/> HYGIENISATION		
/	/	<input type="checkbox"/> OTHER		

NAME, SIGNATURE AND STAMP OF AUTHORISED TECHNICIAN				
/	/	<input type="checkbox"/> START-UP	TECHNICIAN	<input type="checkbox"/> ORDINARY <input type="checkbox"/> EXTRAORDINARY <input type="checkbox"/> GUARANTEE
/	/	<input type="checkbox"/> COMPLETE MAINTENANCE	STAMP	
/	/	<input type="checkbox"/> REPAIR		
/	/	<input type="checkbox"/> HYGIENISATION		
/	/	<input type="checkbox"/> OTHER		
/	/	<input type="checkbox"/> COMPLETE MAINTENANCE	TECHNICIAN	<input type="checkbox"/> ORDINARY <input type="checkbox"/> EXTRAORDINARY <input type="checkbox"/> GUARANTEE
/	/	<input type="checkbox"/> REPAIR	STAMP	
/	/	<input type="checkbox"/> HYGIENISATION		
/	/	<input type="checkbox"/> OTHER		
/	/	<input type="checkbox"/> COMPLETE MAINTENANCE	TECHNICIAN	<input type="checkbox"/> ORDINARY <input type="checkbox"/> EXTRAORDINARY <input type="checkbox"/> GUARANTEE
/	/	<input type="checkbox"/> REPAIR	STAMP	
/	/	<input type="checkbox"/> HYGIENISATION		
/	/	<input type="checkbox"/> OTHER		
/	/	<input type="checkbox"/> COMPLETE MAINTENANCE	TECHNICIAN	<input type="checkbox"/> ORDINARY <input type="checkbox"/> EXTRAORDINARY <input type="checkbox"/> GUARANTEE
/	/	<input type="checkbox"/> REPAIR	STAMP	
/	/	<input type="checkbox"/> HYGIENISATION		
/	/	<input type="checkbox"/> OTHER		
/	/	<input type="checkbox"/> COMPLETE MAINTENANCE	TECHNICIAN	<input type="checkbox"/> ORDINARY <input type="checkbox"/> EXTRAORDINARY <input type="checkbox"/> GUARANTEE
/	/	<input type="checkbox"/> REPAIR	STAMP	
/	/	<input type="checkbox"/> HYGIENISATION		
/	/	<input type="checkbox"/> OTHER		

NOTES:

A large rectangular area with a light blue dotted grid pattern, intended for taking notes.

EC DECLARATION

We DECLARE, hereby assuming our sole responsibility, that the water softening system based on the ion exchange process for the treatment of human consumption water, of the Watermark brand and with serial no.: according to manufacture, complies with the following regulations and standards: **EN-12100-1, EN12100-2, EN-55014-1:2000/ A1:2001, EN-61000-3 2:2000/ A1:2001, EN-61000-3-3: 1995/A1:2001, EN-61558-2-6** and fulfils the essential requirements from directives **98/37/CE, 73/23/CEE, 89/336 /CEE.**

Name and position of the authorised person:
José Antonio Fogued Franco / MANAGER.

Date: **20/01/2013.** Signature and stamp:



Ionfilter· C. Aiguafreda 8 · Pol. Ind. l'Ametlla Park · 08480 L'Ametlla del Vallès · Barcelona · Spain

GUARANTEE CERTIFICATE FOR STRATOS SERIES**SYSTEM GUARANTEE FOR THE END USER:**

The distributor guarantees its systems for two years against any manufacturing defect, in accordance with that laid down in Law RD 1/2007, 16 November (Consolidated text on the General Law for the Defence of Consumers and Users). The guarantee comprises the repair and replacement of defective parts by authorised personnel from the Distributor or the Official Technical Service Assistance (TAS), in the place of installation or their workshops. The guarantee includes the labour and shipment costs that may arise.

Ionfilter shall not offer guarantee for parts suffering usual wear and tear, lack of maintenance, hits and other faults due to the improper use of the system outside specifications and operating limitations indicated by the manufacturer. Likewise the guarantee will not be valid in the event of misuse, or in those cases where it has been modified or repaired by personnel that do not belong to the distributor or the official TAS.

All the replaced parts under guarantee shall remain the property of **Ionfilter**.

Ionfilter shall be held responsible for the lack of conformity when this refers to the origin, identity or compliance of the products, according to its nature and purpose. Taking into account the technical specifications of the systems, it is essential, for the guarantee to be valid, that the technical conditions of the installation and operation are fulfilled. Should this conditions not be fulfilled, the guarantee would remain invalid, taking into account the importance of the system's use as well as the conditions and operating limitations in which it must operate.

The distributor must guarantee that the installed system is appropriate for the improvement of the quality of water that is going to be treated, according to the technical specifications of the system and the regulations in force.

The distributor must guarantee the proper installation and start-up of the system, according to the instructions provided by the manufacturer and the regulations in force. Furthermore, it shall be held responsible for the lack of conformity due to an inaccurate application, installation or start-up of the system.

For any claims under guarantee you are required to provide the receipt of purchase. The term of the 2-year guarantee starts on the date of purchase of the system in your distributor. Should you suffer any problem with the system while it is under guarantee, contact your distributor.

AUTHORISED COMPANY AND/OR TECHNICIAN:

Company and/or technician, date and signature:

The system is installed and in operation as required by the client, and for this to be officially recorded:

*Pre-treatment of the system:

*Input hardness of the system (°F):

*Treated water hardness (°F):

*Residual hardness (°F):

*Input pressure of the system (bar):

***Result of the installation and start-up sheet**

CORRECT. OTHERS:

The owner of the system has been properly and clearly informed about the use, manipulation and maintenance of the system, in order to guarantee a proper operation and the quality of produced water. To such effect, a maintenance contract has been offered.

***Ref. of the maintenance contract**

ACCEPTS the maintenance contract.

DOES NOT ACCEPT the maintenance contract.

For further information, to report a breakdown or that the system is not working properly, and to request maintenance or the assistance of a technician, previously read the sections on how to operate the system, and detection and solution of problems, in this manual and contact the distributor or company where the system was purchased.



AUTHORISED COMPANY AND/OR TECHNICIAN: The information marked with (*) must be filled in and copied by the technician from the INSTALLATION AND START-UP REGISTRATION SHEET OF THE SYSTEM.

CE

 Stratos

IONFILTER[®]
ilusión+innovación

www.ionfilter.com
comercial@ionfilter.es

T: +34 902 305 310
+34 936 934 300
F: +34 936 934 330

C.Aiguafreda,8
Pol. Ind. L'Ametlla Park
08480 L'Ametlla del Vallès
Barcelona, Spain.

 **PuricomEurope**[®]
REVERSE OSMOSIS PURE WATER

www.puricom.eu
puricom@puricom.eu

T: +34 902 305 310
F: +34 936 934 329

C.Aiguafreda,8
Pol. Ind. L'Ametlla Park
08480 L'Ametlla del Vallès
Barcelona, Spain.

 **PuricomAmerica**[®]
REVERSE OSMOSIS PURE WATER

www.puricom.eu
puricom@puricom.eu

T: +34 902 305 310
F: +34 936 934 329

C.Aiguafreda,8
Pol. Ind. L'Ametlla Park
08480 L'Ametlla del Vallès
Barcelona, Spain.